



FLG4 GRAVITY FEED SPRAY GUN AND CUP

IMPORTANT: Before using this equipment, read all safety precautions on page 2 and instructions. Keep for future use.

GUN DESCRIPTION

The FLG4 is a light weight, anodized aluminum, general purpose gravity feed spray gun designed for use in various types of spraying applications. Various models are available to handle HVLP, water based, and solvent based spraying applications.

These guns are sold with either a 900 cc aluminum cup (702576) or a 20 oz. Acetal cup (GFC-501). These guns are suitable for use with water based materials **ONLY** if used with a Acetal cup, or with a disposable cup system.

WARNING

Halogenated hydrocarbon solvents - for example; 1, 1, 1-trichloroethane and methylene chloride - can chemically react with the aluminum in this gun and cause an explosion hazard. Read the label or data sheet for the material you intend to spray. Do not use spray materials containing these solvents with this spray gun.

IMPORTANT: This gun may be used with most common coating and finishing materials. It is designed for use with mildly corrosive and non-abrasive materials. If used with other high corrosive or abrasive materials, it must be expected that frequent and thorough cleaning will be required and the necessity for replacement of parts will be increased.

HVLP MODELS:

HVLP models of this gun were manufactured to provide maximum transfer efficiency by limiting air cap pressure to 10 psi (complies with rules issued by SCAQMD and other air quality authorities).

HVLP models of this gun will produce approximately 10 psi cap pressure at 23 psi gun inlet pressure, as measured at the gun inlet. An air cap test kit (see Accessories) should be used to insure 10 psi cap pressure is not exceeded.

The No. 3 (HVLP) air cap requires a 13 cfm air supply at the gun inlet of 23 psi max., measured with the trigger pulled.

CUP DESCRIPTIONS

702576 – 900 cc Aluminum Cup

The cup is constructed from durable aluminum to provide trouble-free operation. The cup insert is electroless nickel plated brass. The disposable cup lid is recyclable and is constructed with recycled polyethylene. The lid has a unique drip check to prevent paint from dripping out of the vent in the lid.

190252 (GFC-501) – 20 oz. Acetal Cup

The cup and screw-on lid are constructed from durable Acetal to provide trouble-free operation. The lid has a unique drip check to prevent paint from dripping out of the vent in the lid. The cup also has a high grade stainless steel connector which is compatible with water based and all common coating materials.

ASSEMBLY OF CUP TO GUN

This gun has been assembled with a cup gasket (12) (blue) in the fluid inlet of the gun body. Place filter (15) in the cup outlet at this time if desired. See Cup Drawing on page 4. Assemble cup to gun and tighten hand tight.

INSTALLATION

Note

Protective coating and rust inhibitors have been used to keep the gun in good condition prior to shipment. Before using the gun, flush it with solvents so that these materials will be removed from fluid passages.

For maximum transfer efficiency, **do not use more pressure than is necessary to atomize the material being applied.**

Connect the gun to a clean, moisture and oil free air supply using a hose size of at least **5/16" I.D.** hose. Do not use **1/4" I.D.** hose. (25' x 1/4" hose at 18 CFM has a pressure loss of 25 psi. 25' x 5/16" hose at 18 CFM has a pressure loss of 8 psi.)

Note

Depending on hose length, larger I.D. hose may be required. Install a DeVilbiss air adjusting valve at the gun handle and air cap test kit over tip. When gun is triggered on, adjust regulated pressure to desired setting to provide a maximum of 10 psi at the air cap. **Do not use more pressure than is necessary to atomize the material being applied.** Excess pressure will create additional overspray and reduce transfer efficiency.

Note

If quick connects are required, use only high flow quick connects approved for HVLP use, such as DeVilbiss HC-4419 and HC-4719. Other types will not flow enough air for proper gun operation.

Note

If an air adjusting valve is used at the gun inlet, use a DeVilbiss model. Some competitive adjusting valves have significant pressure drop that can adversely affect spray performance. DeVilbiss air adjusting valves have minimal pressure drop, which is important for HVLP spraying.

OPERATION

Mix, prepare and strain the material to be sprayed according to the paint manufacturer's instructions.

FILLING WITH PAINT

Fill the cup with paint to the full mark (702576) or to bottom of the threads (GFC-501). **Do not overfill.**

INSTALLING THE LID

Place plastic lid on the top of the cup, and **push in the center of the lid to assemble lid (702576) or screw lid onto cup (GFC-501).** Fold vent cap and push onto center portion of lid (if vent cap is not already assembled).

(continued on page 3)

IMPORTANT! DO NOT DESTROY

It is the Customer's responsibility to have all operators and service personnel read and understand this manual. Contact your local DeVilbiss representative for additional copies of this manual.

READ ALL INSTRUCTIONS BEFORE OPERATING THIS DEVILBISS PRODUCT.

SAFETY PRECAUTIONS

This manual contains information that is important for you to know and understand. This information relates to USER SAFETY and PREVENTING EQUIPMENT PROBLEMS. To help you recognize this information, we use the following symbols. Please pay particular attention to these sections.

WARNING

Important safety information – A hazard that may cause serious injury or loss of life.

CAUTION

Important information that tells how to prevent damage to equipment, or how to avoid a situation that may cause minor injury.

NOTE





Information that you should pay special attention to.

WARNING

The following hazards may occur during the normal use of this equipment. Please read the following chart before using this equipment.

CA PROP 65

PROP 65 WARNING
WARNING: This product contains chemicals known to the State of California to cause cancer and birth defects or other reproductive harm.

HAZARD	CAUSE	SAFEGUARDS
Fire 	Solvent and coatings can be highly flammable or combustible especially when sprayed.	Adequate exhaust must be provided to keep air free of accumulations of flammable vapors. Smoking must never be allowed in the spray area. Fire extinguishing equipment must be present in the spray area.
Solvent Spray 	During use and while cleaning and flushing, solvents can be forcefully expelled from fluid and air passages. Some solvents can cause eye injury.	Wear eye protection.
Inhaling Toxic Substances 	Certain materials may be harmful if inhaled, or if there is contact with the skin.	Follow the requirements of the Safety Data Sheet supplied by your coating material manufacturer. Adequate exhaust must be provided to keep the air free of accumulations of toxic materials. Use a mask or respirator whenever there is a chance of inhaling sprayed materials. The mask must be compatible with the material being sprayed and its concentration. Equipment must be as prescribed by an industrial hygienist or safety expert, and be NIOSH approved.
Explosion Hazard - Incompatible Materials 	Halogenated hydrocarbon solvents - for example; methylene chloride and 1,1,1, - Trichloroethane are not chemically compatible with the aluminum that might be used in many system components. The chemical reaction caused by these solvents reacting with aluminum can become violent and lead to an equipment explosion.	Guns with stainless steel internal passageways may be used with these solvents. However, aluminum is widely used in other spray application equipment - such as material pumps, regulators, valves, and this gun and cup. Check all equipment items before use and make sure they can also be used safely with these solvents. Read the label or data sheet for the material you intend to spray. If in doubt as to whether or not a coating or cleaning material is compatible, contact your material supplier.
General Safety	Improper operation or maintenance of equipment.	Operators should be given adequate training in the safe use and maintenance of the equipment (in accordance with the requirements of NFPA-33, Chapter 15). Users must comply with all local and national codes of practice and insurance company requirements governing ventilation, fire precautions, operation, maintenance, and housekeeping. These are OSHA Sections 1910.94 and 1910.107 and NFPA-33.
Cumulative Trauma Disorders ("CTD's") CTD's, or musculoskeletal disorders, involve damage to the hands, wrists, elbows, shoulders, neck, and back. Carpal tunnel syndrome and tendonitis (such as tennis elbow or rotator cuff syndrome) are examples of CTD's.	Use of hand tools may cause cumulative trauma disorders ("CTD's"). CTD's, when using hand tools, tend to affect the upper extremities. Factors which may increase the risk of developing a CTD include: <ol style="list-style-type: none"> 1. High frequency of the activity. 2. Excessive force, such as gripping, pinching, or pressing with the hands and fingers. 3. Extreme or awkward finger, wrist, or arm positions. 4. Excessive duration of the activity. 5. Tool vibration. 6. Repeated pressure on a body part. 7. Working in cold temperatures. CTD's can also be caused by such activities as sewing, golf, tennis, and bowling, to name a few.	Pain, tingling, or numbness in the shoulder, forearm, wrist, hands, or fingers, especially during the night, may be early symptoms of a CTD. Do not ignore them. Should you experience any such symptoms, see a physician immediately. Other early symptoms may include vague discomfort in the hand, loss of manual dexterity, and nonspecific pain in the arm. Ignoring early symptoms and continued repetitive use of the arm, wrist, and hand can lead to serious disability. Risk is reduced by avoiding or lessening factors 1-7.

PAINTING

Open the spreader adjustment valve (6) (Fan) by turning the valve stem counterclockwise.

Close the fluid needle adjusting knob (7) by turning clockwise.

Turn on air supply and set gun inlet pressure; 23 psi for HVLP use. Some materials can be sprayed at lower pressures, improving transfer efficiency.

Spray a test area. Turn the fluid needle adjusting knob (7) counterclockwise until a full coat is obtained.

If the finish is too sandy and dry, the material flow may be too low for the atomization air pressure being used. Turn the fluid needle adjusting knob (7) counterclockwise to increase fluid flow.

If the finish sags, there is too much material flowing for the atomization air pressure being used. Turn the fluid needle adjusting knob (7) clockwise to decrease fluid flow.

Pattern width can be altered by turning spreader adjustment valve (6), either clockwise to decrease the width or counterclockwise to increase the width.

Adjust inlet air pressure to provide a uniform dispersion of atomized paint throughout the pattern. Keep air pressure as low as possible to minimize bounce-back and overspray. Excessive pressure will result in split spray patterns. Inadequate pressures will cause heavy centered patterns and poor atomization.

CLEANING

Note

For routine cleaning, it is not necessary to remove cup from gun. Do not remove washer (12) from gun. If washer (12) is removed, it must be replaced.

The 702576 cup lid is designed to be disposable but may be cleaned and reused if slightly contaminated with overspray. **If lid becomes tight, or does not fit, it is due to extended soaking in solvent. Let lid air dry overnight and the lid should return to its original size and fit.**



Do not soak the lid in solvent for extended periods of time. Doing so could cause cup/lid sealing problems and leakage.

Remove lid and properly dispose of any excess paint. Pour in a small amount of clean solvent. The amount will vary with different coatings and solvents. Reinstall lid. Shake cup to wash down the inside surfaces. **Hold 702576 lid while shaking to prevent lid from coming off.** Pull trigger to allow some solvent to be flushed through gun. Remove lid and pour out dirty solvent. Add a small amount of clean solvent and repeat procedure. Wipe exterior of lid with a clean cloth and clean solvent.

If a paint filter was used in the bottom of the cup outlet, it should be removed and cleaned or replaced at this time. Dispose of used cup lid if contaminated and replace with new.

To clean air cap and fluid tip, brush exterior with a stiff bristle brush. If necessary to clean cap holes, use a broom straw or toothpick if possible. If a wire or hard instrument is used, extreme care must be used to prevent scratching or burring of the holes which will cause a distorted spray pattern.

To clean fluid passages, remove excess material at source, then flush with a suitable solvent. Wipe gun exterior with a solvent dampened cloth. Never completely immerse in solvent as this is detrimental to the lubricants and packings.

PREVENTIVE MAINTENANCE

Spray Gun Lubrication

Daily, apply a drop of spray gun lube at trigger bearing stud (11) and the stem of the air valve (9). The shank of the fluid needle (8) where it enters the packing nut (8) should also be oiled. The fluid needle packing (8) should be kept soft and pliable by periodic lubrication. Make sure the baffle (5) and retaining ring (1) threads are clean and free of foreign matter. Before assembling retaining ring to baffle, clean the threads

thoroughly, then add two drops of spray gun lube to threads. The fluid needle spring (7) and air valve spring (9) should be coated with a very light grease, making sure that any excess grease will not clog the air passages. For best results, lubricate the points indicated, daily.

- A. Trigger Points
- B. Packing
- C. Adjusting Valves
- D. Baffle/Air Cap Threads

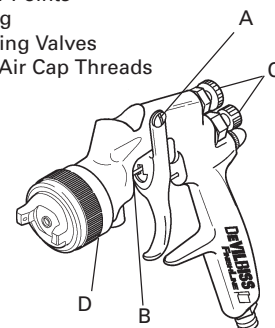

PARTS REPLACEMENT

Note

When replacing the fluid tip or fluid needle, replace both at the same time. Using worn parts can cause fluid leakage. Also, replace the needle packing and fluid tip seal at this time. Lightly lubricate the threads of the fluid tip before reassembling. Torque to 15-20 ft-lbs. Do not overtighten the fluid tip.

The fluid tip part number and tip size are stamped around the outside of the fluid tip.

See Chart 2 for selecting the proper size fluid tip for the material you are spraying.



To prevent damage to the fluid tip (3) or fluid needle (8), be sure to either 1) pull the trigger and hold while tightening or loosening the fluid tip or 2) remove fluid needle adjusting screw (7) to relieve spring pressure against needle collar.

Chart 1 – Air Caps

Air Cap (Ref. No. 2)		Application
Part No.	Computer No.	
FLG-1-1	690000	Conventional
FLG-1-3	690001	HVLP

Chart 2 – Fluid Tips

Fluid Tip (Ref. No. 3)	Fluid Tip Computer No.	Fluid Tip Size (in.)	Fluid Tip Size (mm)	Applications
FLG-332-13K	803051	0.051	1.3	Stains, lacquers, basecoats, clears.
FLG-332-15K	803052	0.059	1.5	General purpose, light to medium viscosity material.
FLG-332-18K	803053	0.070	1.8	Primers and medium viscosity materials.
FLG-332-22K	803054	0.086	2.2	Latex and heavy materials.

Chart 3 – HVLP Air Flows (#3 Cap)

Inlet Press. (PSI)	Air Flow (SCFM)	Cap Press. (PSI)
15	10	6
19	11.5	8
23	13	10

Gun Drawing

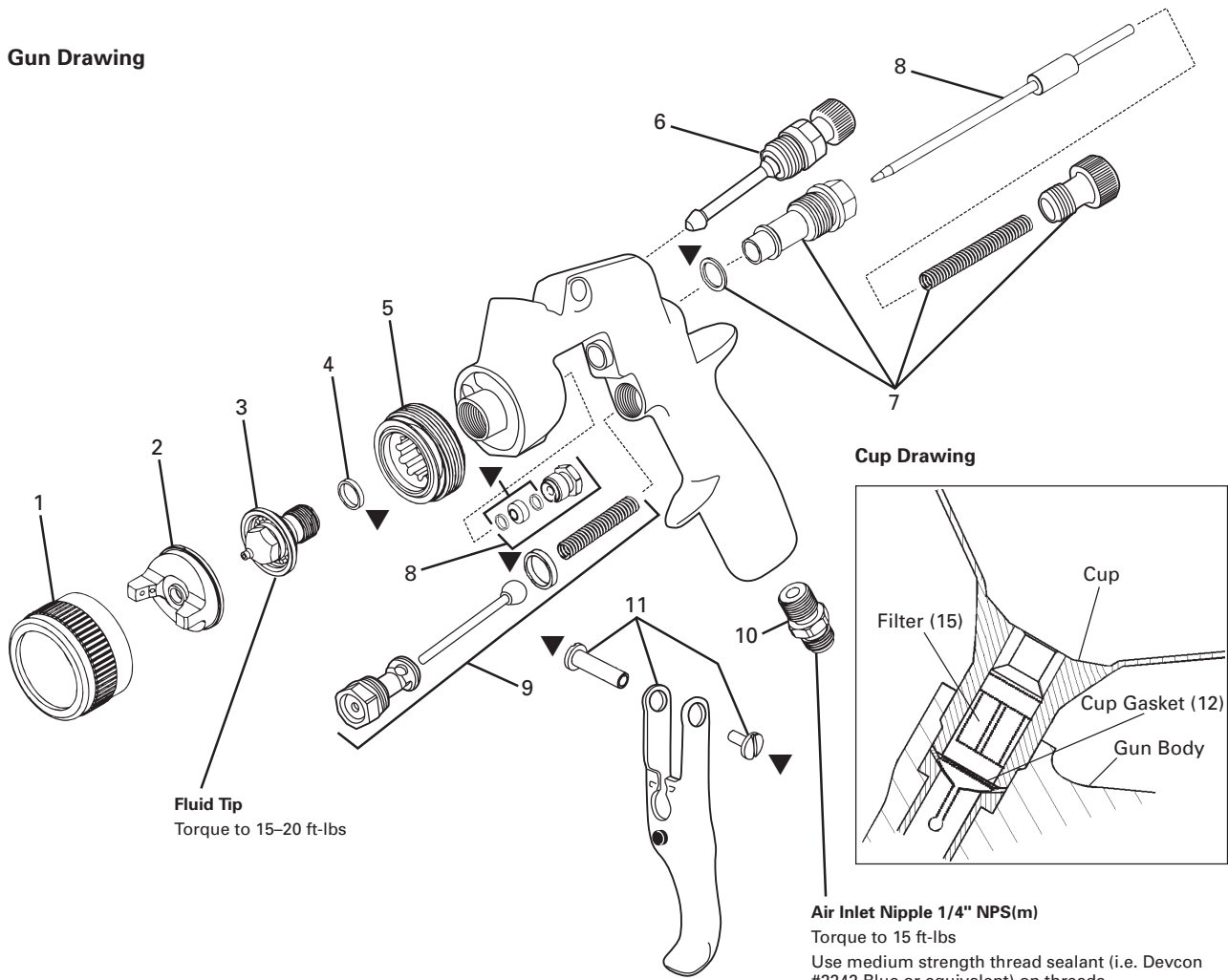

Fluid Tip
Torque to 15–20 ft-lbs

Air Inlet Nipple 1/4" NPS(m)
Torque to 15 ft-lbs
Use medium strength thread sealant (i.e. Devcon #2242 Blue or equivalent) on threads

PARTS LIST

Ref. No.	Comp. Part No.	Replacement Part No.	Description	Ind. Parts Req.
1	803055	FLG-333	Retaining Ring	1
2		See Chart 1	Air Cap	1
3		See Chart 2	Fluid Tip & Seal Kit	1
4	690020	FLG-304-K5	Fluid Tip Seal (Kit of 5)	1
5	690021	FLG-305	Baffle	1
6	803528	FLG-465	Spreader Air Adjustment Valve	1
7	803525	FLG4-364-K	Needle Knob, Spring, Bushing & Gasket Kit	1
8	803526	FLG4-366-K	FLG4 Needle, Needle Packing & Nut Kit	1
9	190780	JGS-449-1	Air Valve & Gasket Kit	1
10	190287	P-MB-51	Air Inlet Nipple	1
11	191943	JGS-477-1	Trigger, Trigger Stud & Screw	1
12	192151	KGP-13-K5	Cup Gasket Kit (Kit of 5)	1
13	702576	702576	Metal Gravity Feed Cup	1
	190252	GFC-501	Acetal Gravity Feed Cup	1
14	190944	GFC-404-K2	Disposable Lid Kit (Kit of 2)	1
15	190181	KGP-5-K5	Filter Kit (Kit of 5)	1

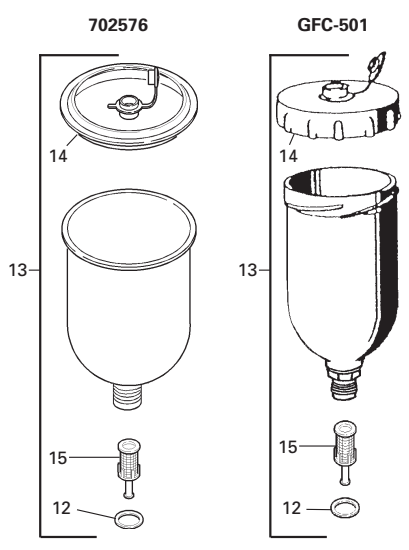





803527 FLG4-488-K ▼ FLG4 Gun Repair Kit (Contains 1 each: Fluid Tip Seal, Needle Packing, Trigger Stud, Trigger Screw, and Gasket for Air Valve & Needle Bushing.)

519210 FLG-463 Air Cap #3 HVLP Test Cap

Additional Spray Gun Accessories on page 7.

TROUBLESHOOTING

CONDITION	CAUSE	CORRECTION
Heavy top or bottom pattern 	Horn holes plugged. Obstruction on top or bottom of fluid tip. Cap and/or tip seat dirty.	Clean. Ream with non-metallic point. Clean. Clean.
Heavy right or left side pattern 	Left or right side horn holes plugged. Dirt on left or right side of fluid tip.	Clean. Ream with non-metallic point. Clean.
Heavy center pattern 	Fluid flow too high for atomization air. Material flow exceeds air cap's capacity. Spreader adjustment valve set too low. Atomizing pressure too low. Material too thick.	Balance air pressure and fluid flow. Increase spray pattern width with spreader adjustment valve. Thin or lower fluid flow. Adjust. Increase pressure. Thin to proper consistency.
Split spray pattern 	Atomization air pressure too high. Fluid flow too low. Spreader adjusting valve set too high.	Reduce at transformer or gun. Increase fluid flow (increases gun handling speed). Adjust.
Jerky or fluttering spray 	*Loose or damaged fluid tip/seat. Material level too low. Container tipped too far. Obstruction in fluid passage. Dry or loose fluid needle packing nut.	Tighten or replace. Refill. Hold more upright. Backflush with solvent. Lubricate or tighten.
Unable to get round spray	Spreader adjustment screw not seating properly. Air cap retaining ring loose.	Clean or replace. Tighten.
Will not spray	No air pressure at gun. Fluid needle adjusting screw not open enough. Fluid too heavy for gravity feed.	Check air supply and air lines, blow out gun air passages. Open fluid needle adjusting screw. Thin material and/or change to larger tip size.
Paint bubbles in cup	Fluid tip not tight.	Tighten tip.
Fluid leaking or dripping from cup lid	Cup lid loose. Dirty threads on cup or lid. Cracked cup or lid.	Tighten lid. Clean. Replace cup and lid.
Starved spray pattern	Inadequate material flow. Low atomization air pressure.	Back fluid adjusting screw out to first thread, or change to larger tip size. Increase air pressure and rebalance gun.
Excessive overspray	Too much atomization air pressure. Gun too far from work surface. Improper stroking (arcing, gun motion too fast).	Reduce pressure. Adjust to proper distance. Move at moderate pace, parallel to work surface.
Excessive fog	Too much or too fast-drying thinner. Too much atomization (air pressure.)	Remix properly. Reduce air pressure.
Dry spray	Air pressure too high. Gun tip too far from work surface. Gun motion too fast. Gun out of adjustment.	Reduce air pressure. Adjust to proper distance. Slow down. Adjust.
Fluid leaking from packing nut	Packing nut loose. Packing worn or dry.	Tighten, do not bind needle. Replace or lubricate.

*Most common problem.

(continued on page 6)

TROUBLESHOOTING (Continued)

CONDITION	CAUSE	CORRECTION
Fluid leaking or dripping from front of gun	Packing nut too tight. Dry packing. Fluid tip or needle worn or damaged. Foreign matter in tip. Fluid needle spring broken. Wrong size needle or tip.	Adjust. Lubricate. Replace tip and needle. Clean. Replace. Replace.
Fluid dripping or leaking from bottom of cup	Cup loose on gun. Cup gasket worn or missing below cup. Cup threads dirty.	Tighten. Replace cup gasket. Clean.
Runs and sags	Too much material flow. Material too thin. Gun tilted on an angle, or gun motion too slow.	Adjust gun or reduce fluid flow. Mix properly or apply light coats. Hold gun at right angle to work and adapt to proper gun technique.
Thin, sandy coarse finish drying before it flows out	Gun too far from surface. Too much air pressure. Improper thinner being used.	Check distance. Normally approximately 8". Reduce air pressure and check spray pattern. Follow paint manufacturer's mixing instructions.
Thick, dimpled finish "orange peel"	Gun too close to surface. Too much material coarsely atomized. Air pressure too low. Improper thinner being used. Material not properly mixed. Surface rough, oily, dirty.	Check distance. Normally approximately 8". Follow paint manufacturer's mixing instructions. Increase air pressure or reduce fluid flow. Follow paint manufacturer's mixing instructions. Follow paint manufacturer's mixing instructions. Properly clean and prepare.

ACCESSORIES

192212 Professional Spray Gun Cleaning Kit

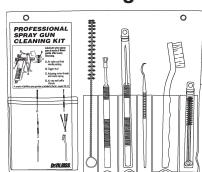

Contains six precision tools designed to effectively clean all DeVilbiss, Binks, Finishline and other brand spray guns.

702576 (Aluminum) 900 cc Cup GFC-501 (Acetal) 20 Oz. Cup Gravity Feed Cups



These gravity feed cups are designed to be used with FLG, GFG, GFHV, GTI or PRI gravity feed spray guns.

HARG-510 Air Regulator

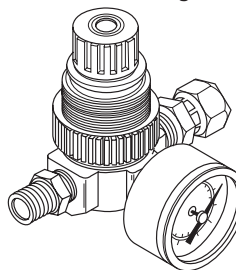

Use to maintain nearly constant outlet pressure despite changes in inlet pressure and downstream flow.

Air Adjusting Valves

- HAV-500 No Gauge
- HAV-512 w/0-100 psi Dial Gauge
- HAV-555 w/0-160 psi Digital Gauge

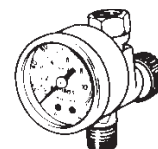

Use to control air usage at gun.

FLG-463 Air Cap Test Kit (#3 air cap)

The purpose of this test kit is to measure air cap atomizing air pressure at the center air port of the air cap. Used to confirm code compliance and as a daily quality control measure.

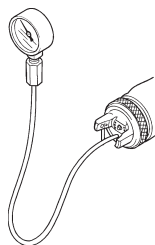

Spray Gun Lube SSL-10 (2 oz. bottle)



Compatible with all paint materials; contains no silicone or petroleum distillates to contaminate paint. SDS Sheet available upon request.

40-128 Twin Cartridge, Paint Spray Respirator



NIOSH-Certified (TC84A-1623) for respiratory protection in atmospheres not immediately dangerous to life.

803616 Multi Spray Gun Holder

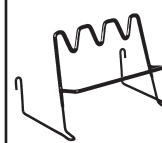

Gun holder for up to three gravity feed spray guns.

WR-103 Wrench

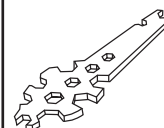

Contains all necessary tip, hose and nut sizes used on or with gun.

Automotive Quick Connects For HVLP Guns (Air) High Flow Type.

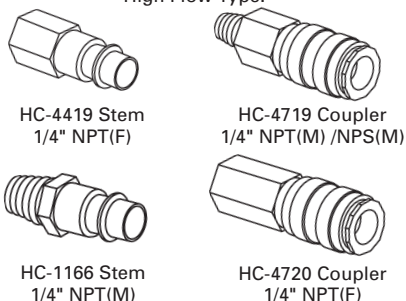

HC-4419 Stem 1/4" NPT(F)

HC-4719 Coupler 1/4" NPT(M) /NPS(M)

HC-1166 Stem 1/4" NPT(M)

HC-4720 Coupler 1/4" NPT(F)

192219 Gun Holder

Gun holder made to hold guns with gravity cups.

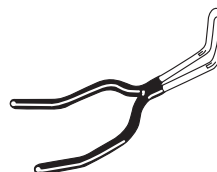

HAF-507 Whirlwind™ In-Line Air Filter

Removes water, oil, and debris from the air line.

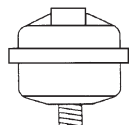

OMX-70-K48 PAINT CUP LINER KIT (Not for use with GFC-503 cups)

Allows quick and easy clean-up.
Consists of:
 1 - Piercing Tool
 48 - Disposable Liners
 48 - Drain Bushings

192218 Scrubs® Hand Cleaner Towels



Scrubs® are a premoistened hand cleaner towel for painters, body men and mechanics that go where you go and no water is needed.



DISTRIBUTED BY COATING EQUIPMENT TECHNOLOGY, INC

WARRANTY POLICY

This product is covered by Carlisle Fluid Technologies' materials and workmanship limited warranty. The use of any parts or accessories, from a source other than Carlisle Fluid Technologies, will void all warranties. Failure to reasonably follow any maintenance guidance provided may invalidate any warranty.

For specific warranty information please contact Carlisle Fluid Technologies.

Carlisle Fluid Technologies is a global leader in innovative finishing technologies. Carlisle Fluid Technologies reserves the right to modify equipment specifications without prior notice.

DeVilbiss®, Ransburg®, ms®, BGK®, and Binks®
are registered trademarks of Carlisle Fluid Technologies, Inc.

©2018 Carlisle Fluid Technologies, Inc.
All rights reserved.

For technical assistance or to locate an authorized distributor,
contact one of our international sales and customer support locations.

Region	Industrial / Automotive	Automotive Refinishing
Americas	Tel: 1-800-992-4657 Fax: 1-888-246-5732	Tel: 1-800-445-3988 Fax: 1-800-445-6643
Europe, Africa, Middle East, India	Tel: +44 (0)1202 571 111 Fax: +44 (0)1202 573 488	
China	Tel: +8621-3373 0108 Fax: +8621-3373 0308	
Japan	Tel: +81 45 785 6421 Fax: +81 45 785 6517	
Australia	Tel: +61 (0) 2 8525 7555 Fax: +61 (0) 2 8525 7575	

For the latest information about our products, visit www.carlisleleft.com