

# JGA-510 (HVLP) SUCTION/PRESSURE FEED SPRAY GUN

MAJOR REPAIR KIT KK-4987-2  
(GOVERNMENT NSN NO. 4940-01-046-9919 = KK-4987-2)

MINOR REPAIR KIT KK-5034

**IMPORTANT: Before using this equipment, read all safety precautions and instructions. Keep for future use.**

## DESCRIPTION

The high volume low pressure JGA-HVLP gun is designed to apply a wide variety of finishing materials. This gun was manufactured to provide maximum transfer efficiency by **limiting air cap pressure to 10 psi (complies with rules issued by SCAQMD and other air quality authorities)**. The gun is available in both suction feed and pressure feed versions of fluid delivery.

This gun will produce approximately 10 psi cap pressure at 50 psi gun inlet pressure, as measured at the gun inlet. An air cap test kit (see Accessories, Page 6) should be used to insure 10 psi air cap pressure is not exceeded.

### Note

This gun includes 300 series stainless steel fluid passages and 400 series tip and needle. Guns may be used with chlorinated solvent materials. See Page 2 for additional warnings.

**IMPORTANT:** This gun may be used with most common coating and finishing materials. It is designed for use with mildly corrosive and nonabrasive materials. If used with other high corrosive or abrasive materials, it must be expected that frequent and thorough cleaning will be required and the necessity for replacement of parts will be increased.

## INSTALLATION

For maximum transfer efficiency, **do not use more pressure than is necessary to atomize the material being applied.**

Connect the gun to a clean, moisture and oil free air supply using a hose size of at least **5/16" I.D.** Do not use 1/4" I.D. hose (25' x 1/4" hose at 18 CFM has a pressure loss of 25 psi. 25' x 5/16" hose at 18 CFM has a pressure loss of 8 psi.

### Note

Depending on hose length, larger I.D. hose may be required. Install a HAV-501 air gauge at the gun handle and air cap test kit over tip. When

gun is triggered on, adjust regulated pressure to desired setting to provide a maximum of 10 psi at the air cap. **Do not use more pressure than is necessary to atomize the material being applied.** Excess pressure will create additional overspray and reduce transfer efficiency.

### Note

If quick connects are required, use only high flow quick connects approved for HVLP use such as DeVilbiss HC-4419 & HC-4699. Other types will not flow enough air for proper gun operation.

### Note

If an air adjusting valve is used at the gun inlet, use DeVilbiss Model HAV-500 or HAV-501. Some competitive adjusting valves have significant pressure drop that can adversely affect spray performance. Models HAV-500 and 501 have minimal pressure drop, which is important for HVLP spraying.

## OPERATION

Strain material thru 60 or 90 mesh screen. Best atomization will occur with 10 psig air cap pressure. However, some materials can be sprayed at lower pressures, improving transfer efficiency.

Open fluid adjusting screw (27) by turning counterclockwise. If gun is a suction feed version, make sure vent hole in suction cup is clean. If gun is a pressure feed version, turn on air to paint supply and adjust fluid pressure to deliver the desired paint volume.

Turn on air supply to gun and set gun inlet pressure to lowest recommended pressure for material being sprayed. Spray a test area. Air pressure and paint flow should be adjusted to provide a uniform dispersion of atomized paint throughout the pattern. Keep air pressure as low as possible to minimize bounce-back and overspray. Excessive fluid flow will result in heavy center spray patterns. Inadequate flows may cause the pattern to split. See TROUBLESHOOTING, page 5, if any problems occur. If finer atomization is required, increase gun inlet pressure. If a reduced fluid flow rate is required, turn fluid adjusting screw (27)

clockwise until desired fluid flow is obtained or reduce fluid pressure (pressure feed only).

Order a free copy of Spray Gun Troubleshooting and Preventive Maintenance Guide, SB-2-001 latest revision, for details concerning setup of spray guns.

## PREVENTIVE MAINTENANCE

To clean air cap and fluid tip, brush exterior with a stiff bristle brush. If necessary to clean cap holes, use a broom straw or toothpick. **Never use a wire or hard instrument.** This may scratch or burr holes causing a distorted spray pattern. See page 6 for gun cleaning accessories.

To clean fluid passages, remove excess material at source. Then proceed as follows:

Suction Feed Guns - Wash out cup with solvent. Wipe off cup suction tube, then fill cup with solvent. Spray until fluid passages are clean.

Pressure Feed Guns - Flush fluid delivery system with a suitable solvent using a device such as the SolventSaver™ (see ACCESSORIES).

Wipe exterior with a solvent dampened cloth, or use 29-3100 Scrubs® (shown on page 6.) Never completely immerse in solvent as this is detrimental to the performance and gun life expectancy, as well as destroying the lubricants and packings.

### Note

When replacing the fluid tip or fluid needle, replace both at the same time. Using worn parts can cause fluid leakage. See Chart 1 for ordering information. Also, replace the needle packing at this time. Lightly lubricate the threads of the fluid tip before reassembling. Torque to 20-25 ft. lbs.

## CAUTION

To prevent damage to fluid tip (3) or fluid needle (32), be sure to either 1) pull the trigger and hold while tightening or loosening the fluid tip, or 2) remove fluid needle adjusting screw (27) to relieve spring pressure against needle collar.

## IMPORTANT! DO NOT DESTROY

It is the Customer's responsibility to have all operators and service personnel read and understand this manual. Contact your local DeVilbiss representative for additional copies of this manual.

**READ ALL INSTRUCTIONS BEFORE OPERATING THIS DEVILBISS PRODUCT.**

**SAFETY PRECAUTIONS**

This manual contains information that is important for you to know and understand. This information relates to **USER SAFETY** and **PREVENTING EQUIPMENT PROBLEMS**. To help you recognize this information, we use the following symbols. Please pay particular attention to these sections.



**Important safety information - A hazard that may cause serious injury or loss of life.**







**Important information that tells how to prevent damage to equipment, or how to avoid a situation that may cause minor injury.**

**Note**

Information that you should pay special attention to.



**The following hazards may occur during the normal use of this equipment. Please read the following chart before using this equipment.**

HAZARD	CAUSES	SAFEGUARDS
 <b>Fire</b>	Solvent and coatings can be highly flammable or combustible especially when sprayed.	Adequate exhaust must be provided to keep air free of accumulations of flammable vapors.  Smoking must never be allowed in the spray area.  Fire extinguishing equipment must be present in spray area.
 <b>Solvent Spray</b>	During use and while cleaning and flushing, solvents can be forcefully expelled from fluid and air passages. Some solvents can cause eye injury.	Wear eye protection.
 <b>Inhaling Toxic Substances</b>	Certain materials may be harmful if inhaled, or if there is contact with the skin.	Follow the requirements of the Safety Data Sheet supplied by your coating material manufacturer.  Adequate exhaust must be provided to keep the air free of toxic materials.  Use a mask or respirator whenever there is a chance of inhaling sprayed materials. The mask must be compatible with the material being sprayed and its concentration. Equipment must be as prescribed by an industrial hygienist and be NIOSH approved.
 <b>Explosion Hazard - Incompatible Materials</b>	Halogenated hydrocarbon solvents - for example; methylene chloride and 1, 1, 1 - Trichloroethane are not chemically compatible with the aluminum that might be used in many system components. The chemical reaction caused by these solvents reacting with aluminum can become violent and lead to an equipment explosion.	Guns with stainless steel internal passageways may be used with these solvents. However, aluminum is widely used in other spray application equipment - such as material pumps, regulators, valves and cups. Check all equipment items before use and make sure they can also be used safely with these solvents. Read the label or data sheet for the material you intend to spray. If in doubt as to whether or not a coating or cleaning material is compatible, contact your material supplier.
<b>General Safety</b>	Improper operation or maintenance of equipment.	Operators should be given adequate training in the safe use & maintenance of the equipment (in accordance with the requirements of NFPA-33, Chapter 15). Users must comply with all local and national codes of practice and insurance company requirements governing ventilation, fire precautions, operation, maintenance and housekeeping. These are OSHA Sections 1910.94 and 1910.107 and NFPA-33.
<b>Cumulative Trauma Disorders (CTD's)</b>  CTD's, or musculo-skeletal disorders, involve damage to the hands, wrists elbows, shoulders, neck and back. Carpal tunnel syndrome and tendinitis (such as tennis elbow or rotor cuff syndrome) are examples of CTD's.	Use of hand tools may cause cumulative trauma disorders ("CTD's").  CTD's, when using hand tools, tend to affect the upper extremities. Factors which may increase the risk of developing a CTD include: 1. High frequency of the activity. 2. Excessive force, such as gripping, pinching or pressing with the hands and fingers. 3. Extreme or awkward finger, wrist, or arm positions. 4. Excessive duration of the activity. 5. Tool vibration. 6. Repeated pressure on a body part. 7. Working in cold temperatures.	Pain, tingling, or numbness in the shoulder, forearm, wrist, hands or fingers, especially during the night, may be early symptoms of a CTD. Do not ignore them. Should you experience any such symptoms, see a physician immediately. Other early symptoms may include vague discomfort in the hand, involve loss of manual dexterity, and nonspecific pain in the arm. Ignoring early symptoms and continued repetitive use of the arm, wrist and hand can lead to serious disability.



**PROP 65 WARNING**  
 WARNING: This product contains chemicals known to the State of California to cause cancer and birth defects or other reproductive harm.

CTD's can also be caused by such activities as sewing, golf, tennis and bowling, to name a few.

### SPRAY GUN LUBRICATION

Daily, apply a drop of •SSL-10 spray gun lube at trigger bearing stud (20) and the stem of the air valve (12) where it enters the air valve assembly (16). The shank of the fluid needle (32) where it enters the packing nut (18) should also be oiled. The fluid needle packing (17) should be lubricated periodically. Make sure the baffle (5) and retaining ring (1) threads are clean and free of foreign matter. Before assembling retaining ring to baffle, clean the threads thoroughly, then add two drops of SSL-10 spray gun lube to threads. The fluid needle spring (29) and air valve spring (11) should be coated with a very light grease, making sure that any excess grease will not clog the air passages. For best results, lubricate the points indicated, daily.

•A Safety Data Sheet is available from DeVilbiss upon request.

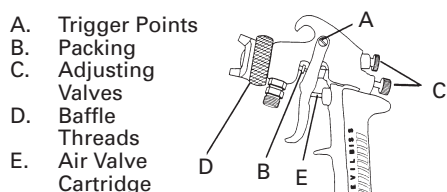

### PARTS REPLACEMENT - FLUID INLET GASKET (6) REPLACEMENT INSTRUCTIONS

1. Remove fluid inlet adapter (8) with appropriate wrench.
2. Clean Loctite from gun body inlet threads and seal area.
3. Place gasket (6) squarely onto the fluid inlet adapter and push it down until it is flat against the shoulder.
4. Place a couple of drops of medium strength thread sealant (i.e. Loctite 242 blue, or equal) on threads before installing fluid inlet adapter.
5. Torque fluid inlet adapter to 20-25 ft. lbs. and tighten locknut.

Figure 1 Baffle

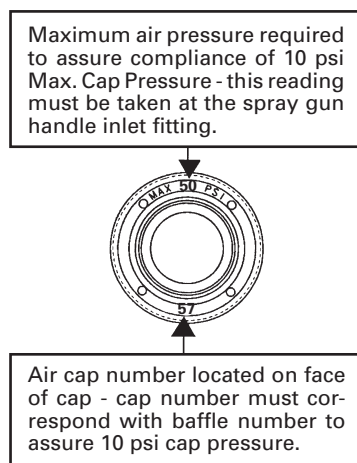

Chart 1

FLUID TIP AND NEEDLE		
Needle	Tip	Tip Size (I.D.) In. mm
JGA-402-DEX	AV-2125-D	.086 2.2
JGA-402-E	AV-2125-DE	.070 1.8
JGA-402-FX	AV-2125-DFX	.042 1.1

**Note:** Do not use AV-1 copper gasket with this spray gun.

Chart 2

AIR CAP & BAFFLE COMBINATION			
No. Stamped on Part		Set	
Air Cap Part No.	Baffle	Ref. No. 2 Air Cap	Ref. No. 5 Baffle
57	57	JGHV-101-57	JGHV-457-57

### JGHV-101-57 Air Cap Performance Charts

Graph 1

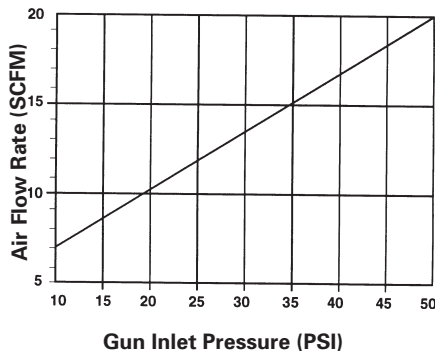

Graph 2

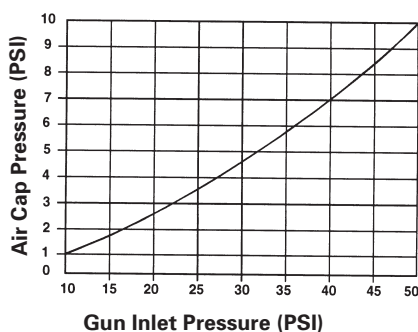

### DISASSEMBLY INSTRUCTIONS - NEW BAFFLE ASSEMBLY

The baffle design incorporates a tight, press fit with the fluid tip, assuring a positive air seal. With this design, the baffle may pull away from the gun body when the tip is removed and stay locked onto the fluid tip. If this occurs, follow the instructions below.

**Note**

A bench vise should be used for convenience and to avoid damage to the spray gun.

1. Secure the spray gun in a bench vise with padded jaws, or use a rag to avoid scratching the gun body.
2. Using a 1/2" socket, loosen the fluid tip three (3) turns only, which will leave about a 1/16" gap between the baffle gasket and gun body. See Figure 2. Do not loosen the fluid tip more than three (3) turns, as damage may occur.

Figure 2

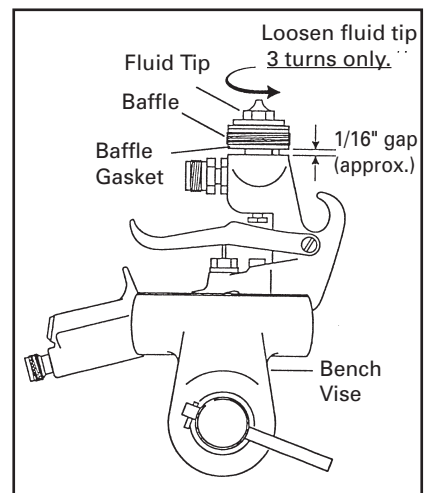

3. Place a 1" socket (12 pt.) over the fluid tip so that it rests on the top surface of the baffle. See Figure 3.
4. Press downward on the socket with sufficient force to free the baffle from the tip. See Figure 3.
5. The fluid tip and baffle can now be removed normally from the gun.

Figure 3

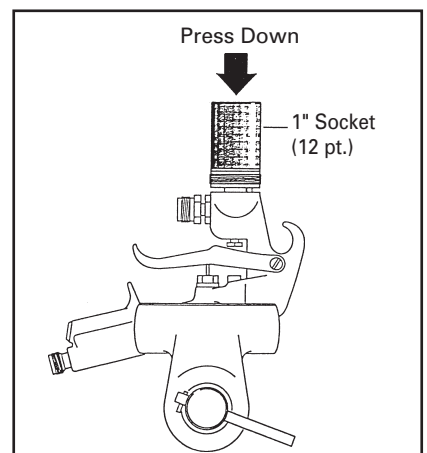

\*\* (Ref. No. 17) Needle Packing Detail (2 piece packing) covered by U.S. Patent No. 5,209,501.  
 + Tapered edge faces out towards packing nut.

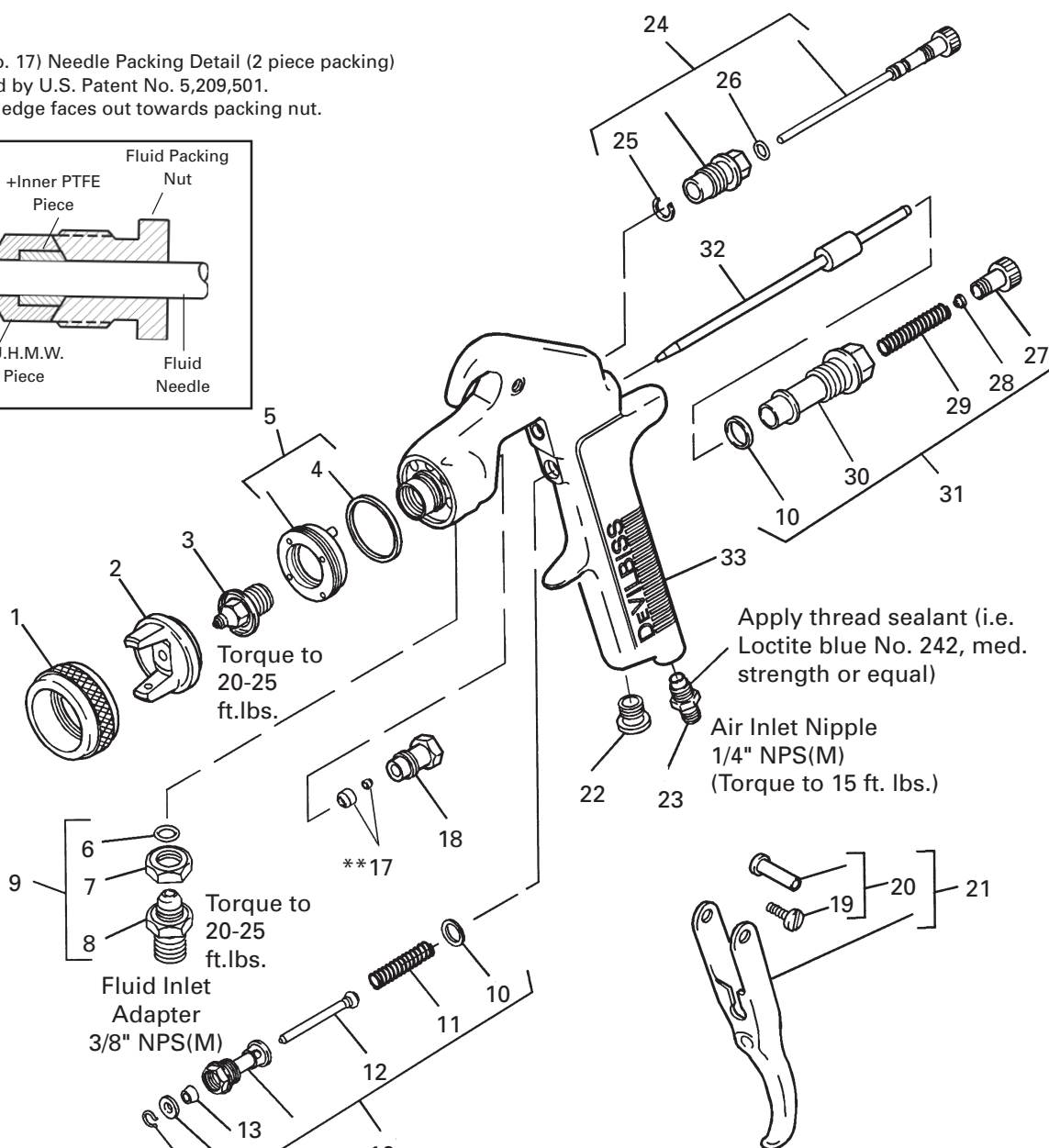
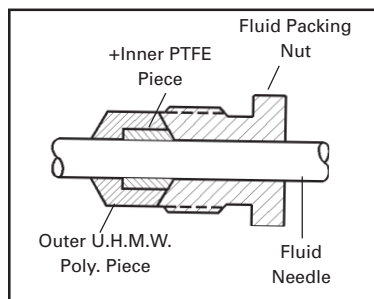





**PARTS LIST**

Ref. No.	Replacement Part No.	Description	Individual Parts Required
1	MBC-368	Retaining Ring .....	1
2	JGHV-101-57	Air Cap .....	1
3	See Chart 1	Fluid Tip .....	1
*4	JGD-14-K10	Gasket Kit, Polyethylene (Kit of 10).....	1
5	JGHV-457-57	Baffle and Gasket Kit .....	1
6	MSV-3-K10	Gasket, PTFE (Blue)(Kit of 10).....	1
7	—	Lock Nut.....	1
8	—	Fluid Inlet Adapter .....	1
9	JGA-4044	Fluid Inlet and Nut Kit.....	1
*10	JGS-72-K10	Gasket Kit, PTFE (Kit of 10) .....	2
*11	MBD-12-K25	Spring Kit (Kit of 25) .....	1
*12	JGS-431-K25	Air Valve Kit (Kit of 25) .....	1
*13	JGS-26-K25	U-Cup Seal Kit (Kit of 25) .....	1
*14	JGA-15-K25	Washer Kit (Kit of 25).....	1
*15	JGA-14-K25	Snap Ring Kit (Kit of 25) .....	1
16	JGS-449-1	Air Valve Assembly.....	1
*17	JGV-463-K3	Packing Kit (Kit of 3) .....	1
18	34411-122-K10	Packing Nut Kit (Kit of 10) .....	1
*19	—	Screw .....	1
20	JGS-478	Stud and Screw Kit.....	1
(Includes 3 studs and 5 screws)			

Ref. No.	Replacement Part No.	Description	Individual Parts Required
21	JGS-477-1	Trigger, Stud and Screw Kit (Kit includes 1 each)	1
22	JGA-132	Plug	1
23	P-MB-51	Nipple	1
24	JGA-497-1	Fan Adjustment Assembly	1
*25	—	Retaining Ring	1
*26	SSG-8069-K25	O-Ring, Viton (Kit of 25)	1
27	JGS-16	Adjusting Screw	1
*28	—	Spring Pad (Included with Nos. 29 & 31)	1
*29	MBD-19-K10	Spring Kit (Kit of 10)	1
30	—	Bushing	1
31	JGA-4041	Bushing, Spring and Knob Kit	1
32	See Chart 1	Fluid Needle	1
33	—	Gun Body	1
#34	See Chart 1	Fluid Tip & Needle Set (not shown)	1

\* A quantity of necessary parts is included in Repair Kit KK-4987-2 for complete gun repair and should be kept on hand for service convenience. For more limited repair, "Soft Parts Kit" KK-5034 is also available (includes items 10, 13, 17, and 26).  
 #Ref. No. 34 includes Ref. Nos. 3 and 32. Copper tip gasket also included but not used with JGA-510 gun.  
 Suffixes -K10 designates kit of multiple parts. Example: JGD-14-K10 is a kit of 10 gaskets.  
 ■ **Government NSN No. 4940-01-046-9919 = KK-4987-2**

## TROUBLESHOOTING







CONDITION	CAUSE	CORRECTION
<b>Heavy top or bottom pattern</b> 	Horn holes plugged. Obstruction on top or bottom of fluid tip. Cap and/or tip seat dirty.	Clean. Ream with non-metallic point. Clean. Clean.
<b>Heavy right or left side pattern</b> 	Left or right side horn holes plugged. Dirt on left or right side of fluid tip.  Remedies for the top-heavy, bottom-heavy, right-heavy, and left-heavy patterns: 1. Determine if the obstruction is on the air cap or the fluid tip. Do this by making a test spray pattern. Then, rotate the cap one-half turn and spray another pattern. If the defect is inverted, obstruction is on the air cap. Clean the air cap as previously instructed. 2. If the defect is not inverted, it is on the fluid tip. Check for a fine burr on the edge of the fluid tip. Remove with #600 wet or dry sand paper. 3. Check for dried paint just inside the opening; remove by washing with solvent.	Clean. Ream with non-metallic point. Clean.
<b>Heavy center pattern</b> 	Fluid flow too high for atomization air. (Pressure Feed)  Material flow exceeds air cap's capacity. Spreader adjustment valve set too low. Atomizing pressure too low. Material too thick.	Balance air pressure and fluid flow. Increase spray pattern width with spreader adjustment valve. Thin or lower fluid flow. Adjust. Increase pressure. Thin to proper consistency.
<b>Split spray pattern</b> 	Atomization air pressure too high. Fluid flow too low. Spreader adjusting valve set too high.	Reduce at transformer or gun. Increase fluid flow (increases gun handling speed). Adjust.
<b>Jerky or fluttering spray</b> 	*Loose or damaged fluid tip/seat. Material level too low. Container tipped too far. Obstruction in fluid passage. Dry or loose fluid needle packing nut. Loose or broken fluid tube or fluid inlet nipple.	Tighten or replace. Refill. Hold more upright. Backflush with solvent. Lubricate or tighten. Tighten or replace.
<b>Unable to get round spray</b>	Spreader adjustment screw not seating properly. Air cap retaining ring loose.	Clean or replace.  Tighten.
<b>Will not spray</b>	No air pressure at gun.  Fluid needle adjusting screw not open enough. Fluid too heavy for gravity feed. Fluid pressure too low.	Check air supply and air lines, blow out gun air passages. Open fluid needle adjusting screw. Thin material and/or change to larger tip size. Increase fluid pressure at tank.
<b>Runs and sags</b>	Too much material flow. Material too thin. Gun tilted on an angle or gun motion too slow.	Adjust gun or reduce fluid pressure. Mix properly or apply light coats. Hold gun at right angle to work and adapt to proper gun technique.
<b>Starved spray pattern</b>	Inadequate material flow.  Low atomization air pressure (suction feed).	Back fluid adjusting screw out to first thread, or increase fluid pressure at tank. Increase air pressure and rebalance gun.
<b>Excessive overspray</b>	Too much atomization air pressure. Gun too far from work surface. Improper stroking (arcing, gun motion too fast).	Reduce pressure. Adjust to proper distance. Move at moderate pace, parallel to work surface.
<b>Excessive fog</b>	Too much or too fast-drying thinner. Too much atomization air pressure.	Remix properly. Reduce pressure.
<b>Dry spray</b>	Air pressure too high. Gun tip too far from work surface. Gun motion too fast. Gun out of adjustment.	Reduce air pressure. Adjust to proper distance. Slow down. Adjust.
<b>Fluid leaking from packing nut</b>	Packing nut loose. Packing worn or dry.	Tighten, do not bind needle. Replace or lubricate.
<b>Fluid leaking or dripping from front of gun</b>	Packing nut too tight. Dry packing. Fluid tip or needle worn or damaged. Foreign matter in tip. Fluid needle spring broken. Wrong size needle or tip.	Adjust. Lubricate. Replace tip and needle with lapped sets. Clean. Replace. Replace.

\*Most common problem.

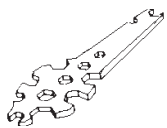
**TROUBLESHOOTING (continued)**

CONDITION	CAUSE	CORRECTION
Thin, sandy coarse finish drying before it flows out	Gun too far from surface. Too much air pressure. Improper thinner being used.	Check distance. Normally approx. 6-8". Reduce air pressure and check spray pattern. Follow paint manufacturer's mixing instructions.
Thick, dimpled finish "orange peel"	Gun too close to surface. Too much material coarsely atomized. Air pressure too low. Improper thinner being used. Material not properly mixed. Surface rough, oily dirty.	Check distance. Normally approx. 6-8". Increase air pressure or reduce fluid pressure. Increase air pressure or reduce fluid pressure. Follow paint manufacturer's mixing instructions. Follow paint manufacturer's mixing instructions. Properly clean and prepare.

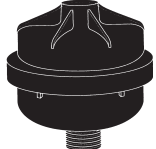
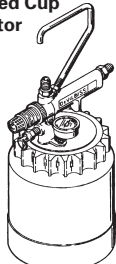
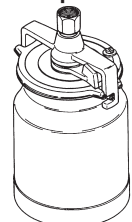
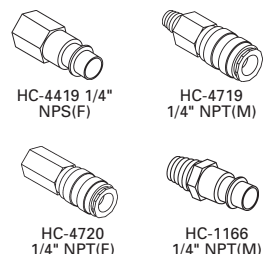
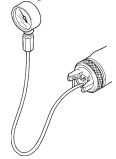
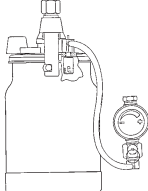
**ACCESSORIES**

<p><b>WR-103 Wrench</b></p>  <p>Contains all necessary tip, hose and nut sizes used on or with gun.</p>	<p><b>JGA-156-K10 Spring Clips</b></p>  <p>Joins any single piece DeVilbiss air cap with latest version MBC-368 or MSA-1 retaining ring. Helps prevent parts loss and provides easier assembly.</p>	<p><b>42884-214-K5 (3/8") &amp; 42884-215-K10 (5/8") Cleaning Brushes</b></p> <p><b>KK-5060 or 192212 Complete Cleaning Kit</b></p>  <p>These brushes are helpful in cleaning threads and recesses of gun body.</p>	<p><b>HAV-500 or HAV-501 Adjusting Valve (HAV-501 shown)</b></p>  <p>HAV-500 does not have pressure gauge. Use to control air pressure at gun.</p>	<p><b>Spray Gun Lube SSL-10-K12 (2 oz. bottle)</b></p>  <p>Compatible with all paint materials: contains no silicone or petroleum distillates to contaminate paint. SDS available upon request.</p>	<p><b>HAF-507 Whirlwind™ In-Line Air Filter</b></p>  <p>Removes water, oil, and debris from the air line.</p>
<p><b>KB-555 (Aluminum) &amp; KB-545-SS (S/S) 2 qt. Pressure Feed Cup With Regulator</b></p>  <p>Provides greater degree of control over cup fluid pressure.</p> <p><b>KB-4006 6-Ft. Fluid and Air Hose</b> can be used with these cups.</p>	<p><b>TGC-545 Aluminum TLC-555 (Non-Stick Coating Lined) TSC-595 (Stainless Steel) Drip Free Suction Cups</b></p>  <p>Cups have a unique, two position valve which permits selection of either a drip free or conventional open vent mode.</p> <p><b>KR-115-K5 Lid Protector Kit</b> keeps inside of lid clean.</p>	<p><b>Quick Disconnect Approved for HVLP Guns (Air) High Flow Ball and Ring Type</b></p>  <p>HC-4419 1/4" NPS(F)      HC-4719 1/4" NPT(M) HC-4720 1/4" NPT(F)      HC-1166 1/4" NPT(M)</p>	<p><b>KK 5033-57 Air Cap Test Kit</b></p>  <p>The purpose of this test kit is to measure air cap atomizing air pressure at the center air port of the air cap. Used to confirm code compliance and as a daily quality control measure.</p>		
<p><b>TLC-576 Aluminum Cup (Non-Stick Coating Lined) &amp; TSC-591 Stainless Steel Cup</b></p>  <p>1 Qt. pressure feed cups. 3/8" NPS (F), cam lock lid. Requires KK-4980 air regulator kit.</p>		<p><b>40-128 Millennium 3000 Twin Cartridge Paint Spray Respirator</b></p>  <p>NIOSH-Certified, for respiratory protection in atmospheres not immediately dangerous to life.</p>	<p><b>29-3100 Scrubs® Hand Cleaner Towels</b></p>  <p>Scrubs® are a pre-moistened hand cleaner towel for painters. No water is needed.</p>		



DISTRIBUTED BY COATING EQUIPMENT TECHNOLOGY, INC

NOTES

## WARRANTY POLICY

DeVilbiss products are covered by Carlisle Fluid Technologies one year materials and workmanship limited warranty. The use of any parts or accessories, from a source other than Carlisle Fluid Technologies, will void all warranties. For specific warranty information please contact the closest Carlisle Fluid Technologies location listed below.

Carlisle Fluid Technologies reserves the right to modify equipment specifications without prior notice. DeVilbiss®, Ransburg®, MS®, BGK®, and Binks® are registered trademarks of Carlisle Fluid Technologies, Inc.

©2017 Carlisle Fluid Technologies, Inc.  
All rights reserved.

---

DeVilbiss is part of Carlisle Fluid Technologies, a global leader in innovative finishing technologies. For technical assistance or to locate an authorized distributor, contact one of our international sales and customer support locations.

### USA/Canada

info@carlisleleft.com  
Tel: 1-888-992-4657  
Fax: 1-888-246-5732

### Mexico

ventas@carlisleleft.com.mx  
Tel: +52 55 5321 2300  
Fax: +52 55 5310 4790

### Germany

info@carlisleleft.eu  
Tel: +49 (0) 6074 403 1  
Fax: +49 (0) 6074 403 281

### United Kingdom

info@carlisleleft.eu  
Tel: +44 (0)1202 571 111  
Fax: +44 (0)1202 573 488

### Japan

overseas-sales@carlisleleft.co.jp  
Tel: +81 45 785 6421  
Fax: +81 45 785 6517

### Australia

sales@carlisleleft.com.au  
Tel: +61 (0) 2 8525 7555  
Fax: +61 (0) 2 8525 7575

### China

mkt@carlisleleft.com.cn  
Tel: +8621-3373 0108  
Fax: +8621-3373 0308

### Brazil

vendas@carlisleleft.com.br  
Tel: +55 11 5641 2776  
Fax: +55 11 5641 1256

For the latest information about our products, visit [www.carlisleleft.com](http://www.carlisleleft.com).