

# DEVILBISS® JGA-510-DEC DECORATOR SPRAY GUN

**IMPORTANT: Before using this equipment, read all safety precautions and instructions. Retain for future use.**

## DESCRIPTION

The JGA-510-DEC is a gun that can apply decorative spatter effects to wood furniture, metal panels, etc. Finish may be changed from a fine mist to larger droplet size particles. Simply adjust fluid pressure and/or air pressure

The JGA-510-DEC comes with the flat-end AV-447 spatter cap assembly. Small spatter dots are the result of coarse atomization when using the standard spatter cap assembly (2).

## OPERATION

### NOTE

This gun may be used with chlorinated solvents. Aluminum is not used in the fluid passage areas.

Mix material according to manufacturer's instructions. It may be necessary to strain material.

A greater than normal gun distance provides a more uniform particle size. Particle spacing is determined by speed of movement and degree of overlap. Particle size is dependent on the material consistency. Specially formulated spatter materials are available, although standard paints may be used. Apply standard paints using very little or no reduction.

Pressure on cup or tank controls material flow. Begin with the fluid needle adjusting screw (32) wide open. Use fluid needle adjusting screw (32) to regulate material flow under abnormally low material pressure or material viscosity conditions.

Adjust atomization air to get desired particle size. It should be high enough to carry particles to surface. Spatter dot size increases with pressure reduction, and decreases with pressure increase. Pressure used depends on material viscosity being sprayed and desired operation speed.

## PREVENTIVE MAINTENANCE

To clean gun passages, blow back paint to material supply source and flush fluid passage with clean solvent. Model HD-503 Gun/Hose Cleaner is a very fast and effective way of cleaning (See Accessories). Wipe gun clean with solvent soaked cloth.

If slots of ring (4) become clogged, clean by soaking cap in solvent and scrubbing with a gun cleaning brush.

### NOTE

When replacing the fluid tip or fluid needle, replace both at the same time. Using worn parts can cause fluid leakage. Also, replace the needle packing at this time.

Using SSL-10 gun lube, lightly lubricate the threads of the fluid tip before reassembling. Torque to 12-15 ft. lbs.

### CAUTION

**To prevent damage to the fluid tip (7) or fluid needle (28), be sure to either 1) pull the trigger and hold while tightening the fluid tip or 2) remove fluid needle adjusting screw to relieve spring pressure.**

## SPRAY GUN LUBRICATION

For best results, lubricate the points indicated, daily. Use SSL-10 Spray Gun Lube to lubricate.

- A. Trigger Points
- B. Packings
- C. Adjusting Valves
- D. Air Baffle Threads

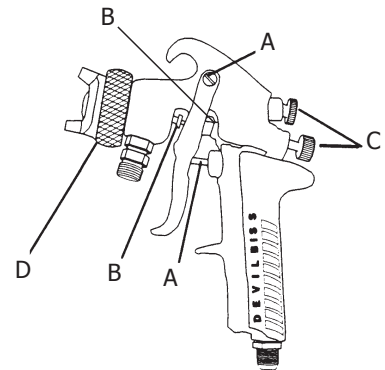

**SAFETY PRECAUTIONS**

This manual contains information that is important for you to know and understand. This information relates to USER SAFETY and PREVENTING EQUIPMENT PROBLEMS. To help you recognize this information, we use the following symbols. Please pay particular attention to these sections.



**Important safety information - A hazard that may cause serious injury or loss of life.**







**Important information that tells how to prevent damage to equipment, or how to avoid a situation that may cause minor injury.**

**NOTE**

Information that you should pay special attention to.



**The following hazards may occur during the normal use of this equipment. Please read the following chart before using this equipment.**

HAZARD	CAUSE	SAFEGUARDS
<p><b>Fire</b></p> 	<p>Solvent and coatings can be highly flammable or combustible, especially when sprayed.</p>	<p>Adequate exhaust must be provided to keep air free of accumulations of flammable vapors.</p> <p>Smoking must never be allowed in the spray area.</p> <p>Fire extinguishing equipment must be present in the spray area.</p>
<p><b>Solvent Spray</b></p> 	<p>During cleaning and flushing, solvents can be forcefully expelled from fluid and air passages. Some solvents can cause eye injury.</p>	<p>Wear eye protection.</p>
<p><b>Inhaling Toxic Substances</b></p> 	<p>Certain materials may be harmful if inhaled, or if there is contact with the skin.</p> <p>sprayed and its concentration. Equipment must</p>	<p>Follow the requirements of the Material Safety Data Sheet supplied by your coating material manufacturer.</p> <p>Adequate exhaust must be provided to keep the air free of accumulations of toxic materials.</p> <p>Use a mask or respirator whenever there is a chance of inhaling sprayed materials. The mask must be compatible with the material being</p> <p>be as prescribed by an industrial hygienist or safety expert, and be NIOSH approved.</p>
<p><b>Explosion Hazard -</b></p> 	<p>Halogenated hydrocarbon solvents - for example; methylene chloride and 1, 1, 1 - Trichloroethane can chemically react with aluminum. The chemical reaction caused by these solvents reacting with aluminum can become violent and lead to an equipment explosion.</p>	<p>This gun can be used with these solvents. However, aluminum is widely used in other spray application equipment - such as, material pumps, cups, regulators, valves, etc. Check all other equipment items before use and make sure they can also be used safely with these solvents. Read the label or material data sheet for the material you intend to spray. If in doubt as to whether or not a coating or cleaning material is compatible, contact your material supplier.</p>

PARTS LIST

Ref. No.	Part No.	Description	Individual Parts Req.
1	MBC-231	Retaining Nut	1
2	AV-447	Spatter Cap Assembly (Flat)	1
3	---	Cap	1
4	---	Ring	1
5	---	Gasket	1
6	MSV-3-K10	Gasket, Teflon (Blue) (Kit of 10)	1
7	JGA-4040-VF	Fluid Tip and Needle, Matched (Includes Item 28)	1
8	---	Lock Nut	1
9	---	Fluid Inlet Adapter	1
10	JGA-4044	Fluid Inlet and Nut Kit	1
•11	JGV-463-K3	Needle Packing (Kit of 3)	1
12	34411-122-K10	Packing Gland (Kit of 10)	1
13	---	Trigger Bearing Stud	1
•14	---	Screw	1
15	JGS-478	Stud and Screw Kit (3 studs and 5 screws in kit)	1
16	JGA-477	Trigger, Stud and Screw Kit (Kit includes 1 each)	1
•17	JGA-14-K25	Snap Ring (Kit of 25)	1
•18	JGA-15-K25	Washer (Kit of 25)	1
•19	JGS-26-K25	U Cup Seal (Kit of 25)	1
•20	JGS-431-K25	Air Valve (Kit of 25)	1
•21	MBD-12-K25	Spring (Kit of 25)	1
•22	JGS-72-K10	Gasket (Kit of 10)	2
23	JGS-449-1	Air Valve Assembly	1
24	JGA-132	Plug	2

Ref. No.	Part No.	Description	Individual Parts Req.
25	P-MB-51	Nipple	1
•26	GTI-33-K5	Seal Kit (Kit of 5)	1
27	JGA-4074	Baffle Assembly	1
28	---	Fluid Needle (Included with Item 7)	1
29	---	Bushing	1
•30	MBD-19-K10	Spring (Kit of 10)	1
•31	---	Spring Pad (Included with Item 30)	1
32	JGS-16	Fluid Needle Adjusting Screw	1
33	JGA-4041	Bushing, Spring & Knob Kit	1

• These parts are included in Repair Kit KK-4987-2 and should be kept on hand for service convenience.  
 Suffixes - K5, K10 designate kits of multiple parts.  
 (Example) JGV-463-K3 is a kit of 3 packings.

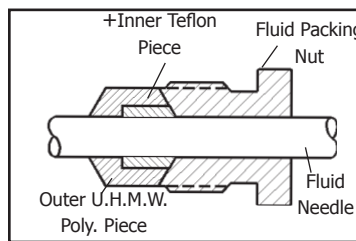

▲ (Ref. No. 11) Needle Packing (2 piece packing) covered by U.S. Patent No. 5,209,501.  
 +Tapered edge faces out towards packing nut.

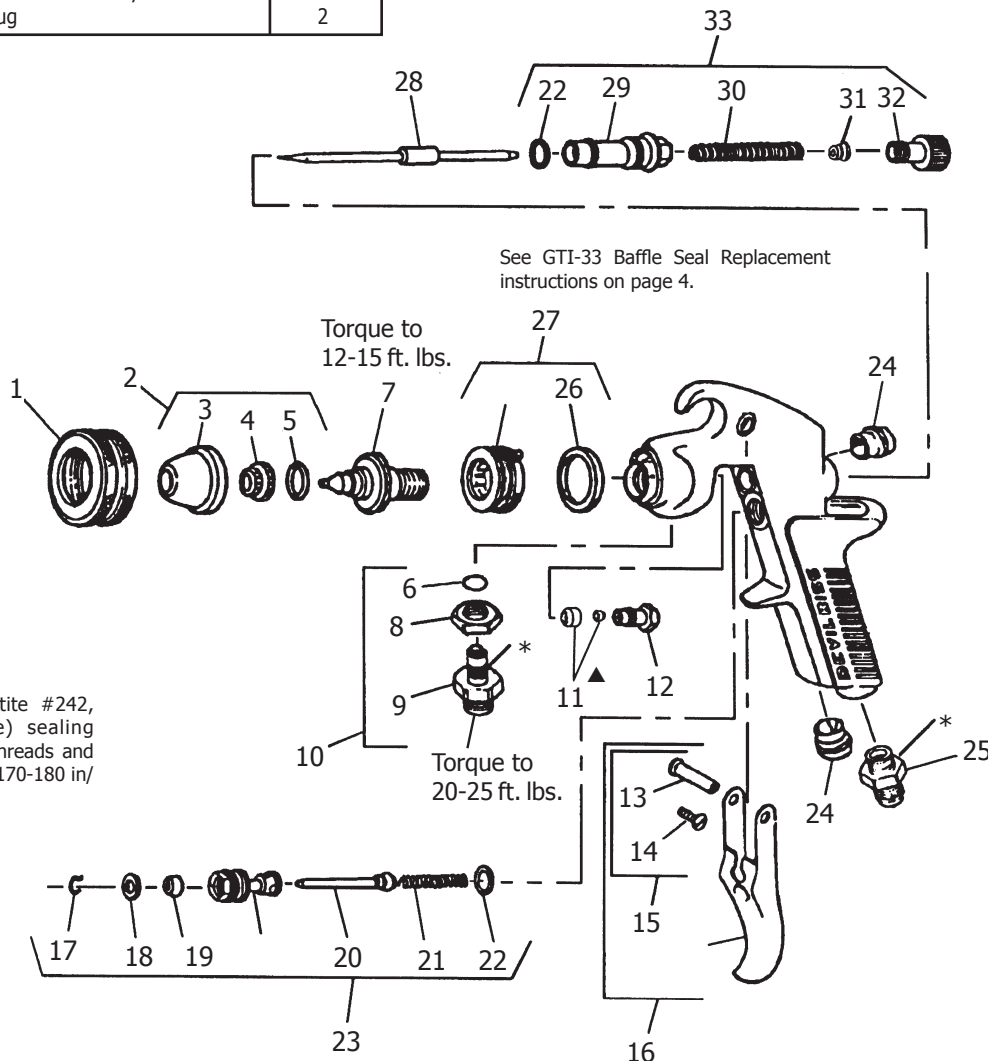

NOTE

\*Apply QH-130 (Loctite #242, med. strength blue) sealing compound onto the threads and screw into place with 170-180 in/lb. torque.

## GTI-33 Baffle Seal Replacement (26)

1. Remove fluid tip (7).
2. Remove baffle (27).
3. Remove seal (26) from baffle.
4. Assemble seal to baffle with **angled side up** as shown at right.

**NOTE**

The seal should be a tight fit on the baffle. If it is a loose fit on the baffle, assure that it is assembled with the angled side up.

6. Install fluid tip (7) and tighten to 12-15 ft-lbs.

**NOTE**

The seal is designed to be a tight fit on the baffle. The seal should be able to be removed using your fingers. If you are unable to remove the seal using your fingers, insert a small screwdriver between the outer lip and the back of the baffle and pry the seal off.

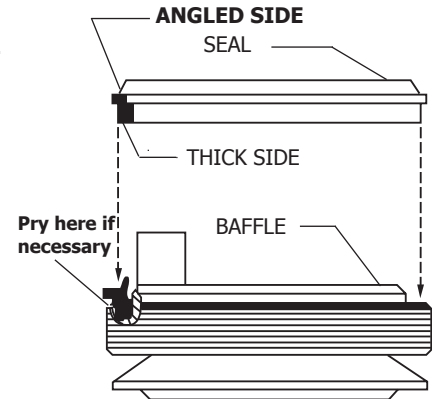

5. Install baffle on gun.

## ACCESSORIES

**WR-103 WRENCH**

Contains all necessary tip, hose and nut sizes used on or with gun.

**42884-214-K5 3/8" 42884-215-K10 5/8" CLEANING BRUSHES**

These brushes are helpful in cleaning threads and recesses of gun body.

**HD-503 SOLVENT SAVER™ GUN/HOSE CLEANER**

2 qt. Hose/Gun Cleaner used to clean the inside of hose, fluid passageways of gun and other paint equipment.

**SPRAY GUN LUBE SSL-10-K12 (2 oz. bottle)**

Compatible with all paint materials: contains no silicone or petroleum distillates to contaminate paint. An MSDS Sheet is available upon request.

**HAV-500 OR HAV-501 Adjusting Valve (HAV-501 SHOWN)**

HAV-500 does not have pressure gauge. Use to control air usage at gun.

**HARG-510 AIR REGULATOR**

Use to maintain nearly constant outlet pressure despite changes in inlet pressure and downstream flow.

**Millennium 3000 Twin Cartridge, Paint Spray Respirator**

NIOSH-Certified (TC-84A-1623) for respiratory protection in atmospheres not immediately dangerous to life.

**HAF-507 Whirlwind™ In-Line Air Filter**

Removes water, oil, and debris from the air line.

**KB-555 Alum. & KB-545-SS Stainless Steel 2 Qt. Pressure Feed Cups**

Includes a 0-30 psi gauge.

**29-3100 Scrubs® Hand Cleaner Towels**

Scrubs® are a pre-moistened hand cleaner towel for painters, body men and mechanics that go where you go and no water is needed.



DISTRIBUTED BY COATING EQUIPMENT TECHNOLOGY, INC

---

**NOTES**

**NOTES**

---

**NOTES**

---

## WARRANTY POLICY

This product is covered by Carlisle Fluid Technologies' materials and workmanship limited warranty. The use of any parts or accessories, from a source other than Carlisle Fluid Technologies, will void all warranties. Failure to reasonably follow any maintenance guidance provided may invalidate any warranty.

For specific warranty information please contact Carlisle Fluid Technologies.

Carlisle Fluid Technologies is a global leader in innovative finishing technologies. Carlisle Fluid Technologies reserves the right to modify equipment specifications without prior notice.

DeVilbiss®, Ransburg®, ms®, BGK®, and Binks®  
are registered trademarks of Carlisle Fluid Technologies, Inc.

©2018 Carlisle Fluid Technologies, Inc.  
All rights reserved.

---

For technical assistance or to locate an authorized distributor,  
contact one of our international sales and customer support locations.

<b>Region</b>	<b>Industrial / Automotive</b>	<b>Automotive Refinishing</b>
Americas	Tel: 1-800-992-4657 Fax: 1-888-246-5732	Tel: 1-800-445-3988 Fax: 1-800-445-6643
Europe, Africa, Middle East, India	Tel: +44 (0)1202 571 111 Fax: +44 (0)1202 573 488	
China	Tel: +8621-3373 0108 Fax: +8621-3373 0308	
Japan	Tel: +81 45 785 6421 Fax: +81 45 785 6517	
Australia	Tel: +61 (0) 2 8525 7555 Fax: +61 (0) 2 8525 7575	

For the latest information about our products, visit [www.carlisleleft.com](http://www.carlisleleft.com)