

# JGA-510-98FX

## PRESSURE FEED HIGH VOLUME LOW PRESSURE SPRAY GUN

Major Repair Kit KK-4987-2  
Minor Repair Kit KK-5034

**IMPORTANT:** Before using this equipment, read all safety precautions and instructions. Keep for future use.

### MODEL NUMBER

JGA-510-98FX Full Size Gun Body

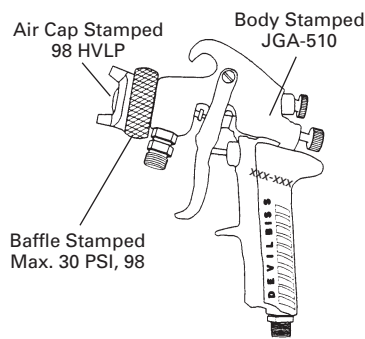

### DESCRIPTION

The JGA-HVLP pressure feed gun incorporates a **LOW CFM HVLP** air cap (#98) which is capable of spraying a wide variety of materials (low to medium solids), at fluid flows typically in the 7 to 10 ounce/minute range.

**Air consumption for the #98 air cap is approximately 11 SCFM @ 10 psi cap pressure. Inlet air pressure of approximately 30 psi (measured at gun handle, flowing) is required to achieve 10 psi cap pressure. The actual air cap pressure can be verified by using an air cap test kit (see Accessories, page 6).**

The gun model also includes a conversion air baffle, which converts the higher incoming pressure to low pressure (HVLP).

All other components, with the exception of the air cap and baffle, are identical to other conventional air spray JGA-510 models.

This gun model includes 300 series stainless steel needles and 400 series fluid tips. See

page 3 for the 300 series tip and needle which may be ordered separately. This gun can be used with chlorinated solvent materials, but see page 2 for additional warnings.

**IMPORTANT:** This gun may be used with most common coating and finishing materials. It is designed for use with mildly corrosive and non-abrasive materials. If used with other high corrosive or abrasive materials, it must be expected that frequent and thorough cleaning will be required and the necessity for replacement of parts will be increased.

### INSTALLATION

Connect the spray gun to a clean, oil and moisture free air supply. The air inlet (located at the base of the gun handle) includes a 1/4" NPS (M) connection.

Be sure to use hose with an ID of at least 5/16". **DO NOT** use 1/4" ID air hose which is restrictive and will cause excessive pressure drop (example - at 18 CFM, 25 ft. of 1/4" hose has a pressure loss of 25 psi, but 25 ft. of 5/16" hose at 18 CFM has a pressure loss of only 8 psi).

If quick air disconnects are required, use only higher flowing models approved for HVLP use, such as those shown on *Accessories*, page 6. Other types or brands may be restrictive and may not flow enough air for proper gun operation.

Connect the fluid hose to the fluid inlet connection (3/8" NPS) located under the spray head. Properly tighten with a wrench.

### OPERATION

Strain material thru 60 or 90 mesh screen. Adjust fluid pressure to deliver the desired paint volume. Adjust air pressure and flow to provide a uniform dispersion of atomized paint throughout the pattern. Keep air pressure as low as possible to minimize bounce-back and overspray. Excessive fluid flow will result in heavy center spray patterns. Inadequate flows may cause the pattern to

split. See TROUBLESHOOTING, page 5, if any problems occur.

For maximum transfer efficiency, do not use more air pressure than is necessary to atomize the material being applied. Excessive air pressure will create additional overspray and bounce-back, reducing transfer efficiency. If an air cap test kit is used (see *Accessories*, page 6), verify air cap pressure after acceptable atomization is achieved. Make a note of the air cap pressure for future reference and daily process control.

### PREVENTIVE MAINTENANCE

To clean air cap and fluid tip, brush exterior with a stiff bristle brush. If necessary to clean cap holes, use a broom straw or toothpick. **Never use a wire or hard instrument.** This may scratch or burr holes causing a distorted spray pattern.

To clean fluid passages, remove excess material at source, then flush with a suitable solvent using a device such as the SolventSaver™ (See ACCESSORIES). Wipe gun exterior with a solvent dampened cloth. Never completely immerse in solvent as this is detrimental to the lubricants and packings.

### SPRAY GUN LUBRICATION

Daily, apply a drop of SSL-10 spray gun lube at trigger bearing stud (20) and the stem of the air valve (12) where it enters the air valve assembly (16). The shank of the fluid needle (32) where it enters the packing nut (18) should also be oiled. The fluid needle packing (17) should be lubricated periodically. Make sure the baffle (5) and retaining ring (1) threads are clean and free of foreign matter. Before assembling retaining ring to baffle, clean the threads thoroughly, then add two drops of SSL-10 spray gun lube to threads. The fluid needle spring (29) and air valve spring (11) should be coated with a very light grease, making sure that any excess grease will not clog the air passages. For best results, lubricate the points indicated, daily.

### IMPORTANT! DO NOT DESTROY

It is the Customer's responsibility to have all operators and service personnel read and understand this manual. Contact your local DeVilbiss representative for additional copies of this manual.

**READ ALL INSTRUCTIONS BEFORE OPERATING THIS DEVILBISS PRODUCT.**

**SAFETY PRECAUTIONS**

This manual contains information that is important for you to know and understand. This information relates to USER SAFETY and PREVENTING EQUIPMENT PROBLEMS. To help you recognize this information, we use the following symbols. Please pay particular attention to these sections.



**Important safety information – A hazard that may cause serious injury or loss of life.**



**Important information that tells how to prevent damage to equipment, or how to avoid a situation that may cause minor injury.**

**Note**

Information that you should pay special attention to.



**The following hazards may occur during the normal use of this equipment. Please read the following chart before using this equipment.**



**PROP 65 WARNING**

**WARNING:** This product contains chemicals known to the State of California to cause cancer and birth defects or other reproductive harm.

HAZARD	CAUSE	SAFEGUARDS
	Solvent and coatings can be highly flammable or combustible especially when sprayed.	<p>Adequate exhaust must be provided to keep air free of accumulations of flammable vapors.</p> <p>Smoking must never be allowed in the spray area.</p> <p>Fire extinguishing equipment must be present in the spray area.</p>
	During use and while cleaning and flushing, solvents can be forcefully expelled from fluid and air passages. Some solvents can cause eye injury.	Wear eye protection.
	Certain materials may be harmful if inhaled, or if there is contact with the skin.	<p>Follow the requirements of the Safety Data Sheet supplied by your coating material manufacturer.</p> <p>Adequate exhaust must be provided to keep the air free of toxic materials.</p> <p>Use a mask or respirator whenever there is a chance of inhaling sprayed materials. The mask must be compatible with the material being sprayed and its concentration. Equipment must be as prescribed by an industrial hygienist or NIOSH approved.</p>
	Halogenated hydrocarbon solvents – for example; methylene chloride and 1, 1, 1 - Trichloroethane are not chemically compatible with the aluminum that might be used in many system components. The chemical reaction caused by these solvents reacting with aluminum can become violent and lead to an equipment explosion.	Guns with stainless steel internal passageways may be used with these solvents. However, aluminum is widely used in other spray application equipment – such as material pumps, regulators, valves and cups. Check all equipment items before use and make sure they can also be used safely with these solvents. Read the label or data sheet for the material you intend to spray. If in doubt as to whether or not a coating or cleaning material is compatible, contact your material supplier.
<p><b>General Safety</b></p>	Improper operation or maintenance of equipment.	Operators should be given adequate training in the safe use & maintenance of the equipment (in accordance with the requirements of NFPA-33, Chapter 15). Users must comply with all local and national codes of practice & insurance company requirements governing ventilation, fire precautions, operation, maintenance and housekeeping. These are OSHA Sections 1910.94 and 1910.107 and NFPA-33.
<p><b>Cumulative Trauma Disorders (CTD's)</b></p> <p>CTD's, or musculo-skeletal disorders, involve damage to the hands, wrists elbows, shoulders, neck and back. Carpal tunnel syndrome and tendinitis (such as tennis elbow or rotor cuff syndrome) are examples of CTD's.</p>	<p>Use of hand tools may cause cumulative trauma disorders ("CTD's").</p> <p>CTD's, when using hand tools, tend to affect the upper extremities. Factors which may increase the risk of developing a CTD include:</p> <ol style="list-style-type: none"> <li>1. High frequency of the activity.</li> <li>2. Excessive force, such as gripping, pinching, or pressing with the hands and fingers.</li> <li>3. Extreme or awkward finger, wrist, or arm positions.</li> <li>4. Excessive duration of the activity.</li> <li>5. Tool vibration.</li> <li>6. Repeated pressure on a bod part.</li> <li>7. Working in cold temperatures.</li> </ol> <p>CTD's can also be caused by such activities as sewing, golf, tennis and bowling, to name a few.</p>	<p>Pain, tingling, or numbness in the shoulder, forearm, wrist, hands or fingers, especially during the night, may be early symptoms of a CD. Do not ignore them. Should you experience any such symptoms, see a physician immediately. Other early symptoms may include vague discomfort in the hand, involve loss of manual dexterity, and nonspecific pain in the arm. Ignoring early symptoms &amp; continued disability.</p>

## SPRAY GUN LUBRICATION (Cont'd)

- Trigger Points
- Packing
- Adjusting Valves
- Baffle Threads
- Air Valve Cartridge

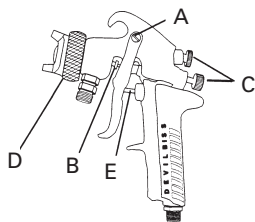

## PARTS REPLACEMENT

### Note

When replacing the fluid tip or fluid needle, replace both at the same time. Using worn parts can cause fluid leakage. Lapped sets are available for most pressure feed combinations. See Chart 1. Lapped sets are particularly recommended with thinner, less viscous materials. Also, replace the needle packing at this time. Lightly lubricate the threads of the fluid tip before reassembling. Torque to 20-25 ft.lbs.

### CAUTION

To prevent damage to the fluid tip (3) or fluid needle (32), be sure to either 1) pull the trigger and hold while tightening or loosening the fluid tip or 2) remove fluid needle adjusting screw (27) to relieve spring pressure against needle collar.

## FLUID INLET GASKET (6) REPLACEMENT INSTRUCTIONS

- Remove fluid inlet adapter (8) with appropriate wrench.
- Clean Loctite from gun body inlet threads and seal area.
- Place gasket (6) squarely onto the fluid inlet adapter and push it down until it is flat against the shoulder.
- Place a couple of drops of QH-130 (medium strength blue No. 242 Loctite) on threads before installing fluid inlet adapter.
- Torque fluid inlet adapter to 20-25 ft. lbs. and tighten locknut.

Maximum air pressure required to assure compliance of 10 psi Max. Cap Pressure – this reading must be taken at the spray gun handle inlet fitting.

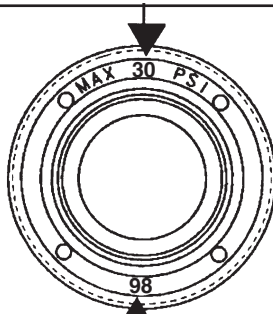

Figure 1 Baffle

Air cap number located on face of cap – cap number must correspond with baffle number to assure 10 psi cap pressure.

## Chart 1

### Fluid Tip and Needle (Matched Set)

400 Gr. S.S. Tip/303 S.S. Needle (Standard)  
AV-2115-FX Tip (.042")  
JGA-402-FX Needle

300 Gr. S.S. Tip with U.H.M.W.  
Poly. Insert / 303 S.S. Needle (optional)  
AV-4915-FX Tip (.042")  
JGA-402-FX Needle

## DISASSEMBLY INSTRUCTIONS – NEW BAFFLE ASSEMBLY

The baffle design incorporates a tight, press fit with the fluid tip, assuring a positive air seal. With this design, the baffle may pull away from the gun body when the tip is removed and stay locked onto the fluid tip. If this occurs, follow the instructions below.

### Note

A bench vise should be used for convenience and to avoid damage to the spray gun.

- Secure the spray gun in a bench vise with padded jaws, or use a rag to avoid scratching the gun body.
- Using a 1/2" socket, loosen the fluid tip three (3) turns only, which will leave about a 1/16" gap between the baffle gasket and gun body. See Figure 2. Do not loosen the fluid tip more than three (3) turns, as damage may occur.

Figure 2

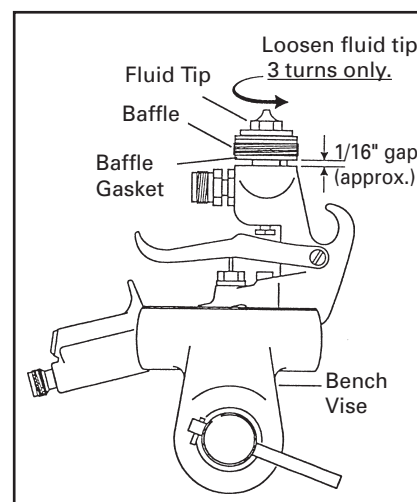

- Place a 1" socket (12 pt.) over the fluid tip so that it rests on the top surface of the baffle. See Figure 3.
- Press downward on the socket with sufficient force to free the baffle from the tip. See Figure 3.
- The fluid tip and baffle can now be removed normally from the gun.

Figure 3

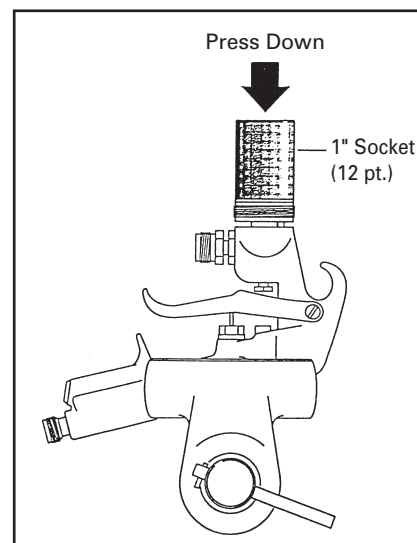

◆(Ref. No. 17) Needle Packing Detail (2 piece packing) covered by U.S. Patent No. 5,209,501.  
 +Tapered edge faces out towards packing nut.

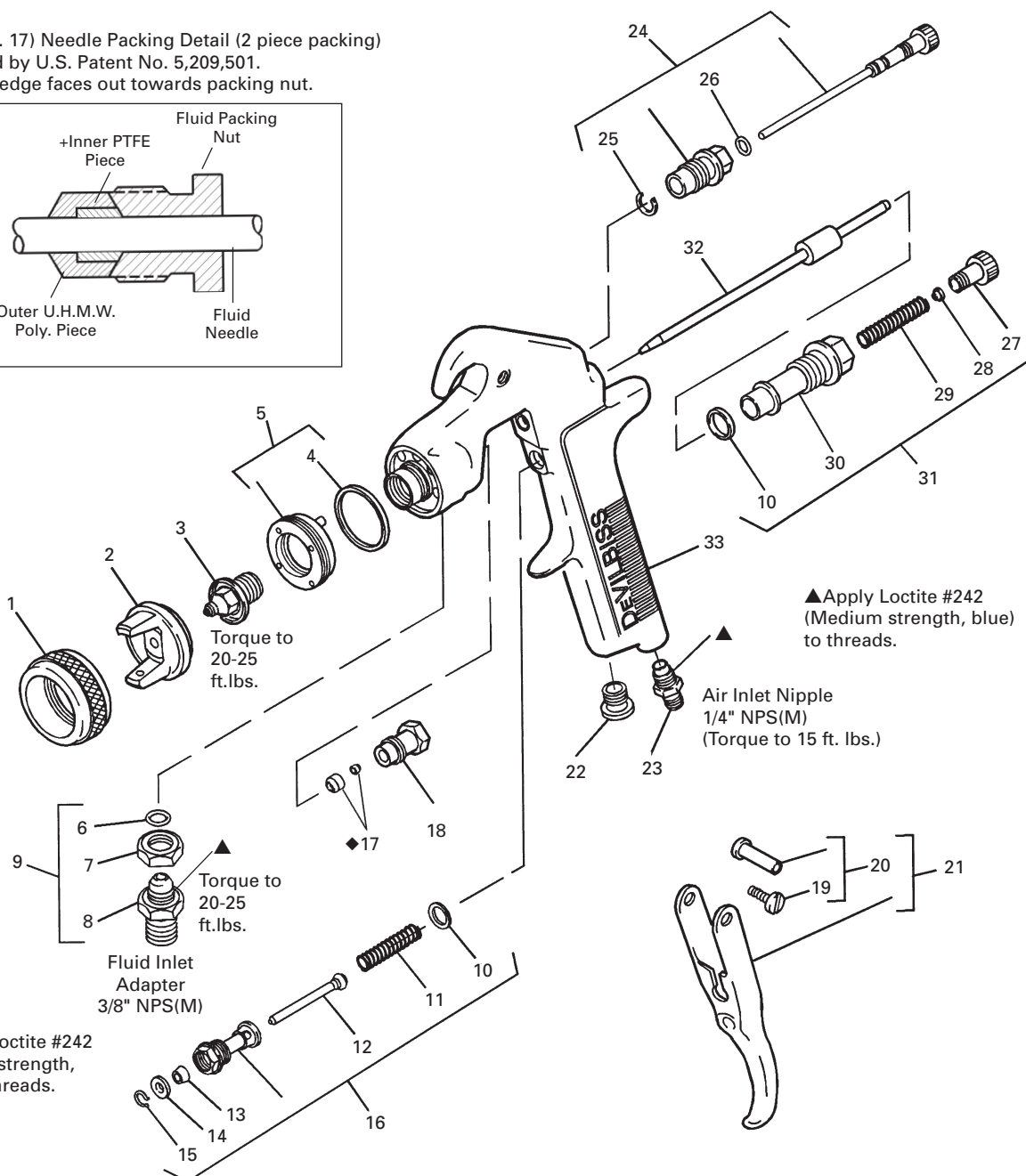
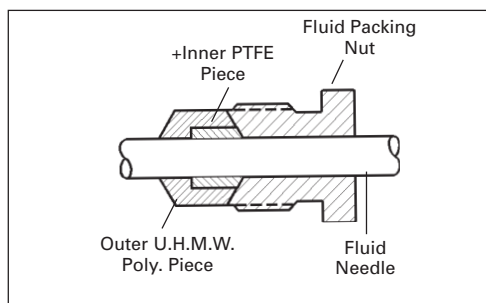





**PARTS LIST**

Ref. No.	Replacement Part No.	Description	Individual Parts Required
1	MBC-368	Retaining Ring	1
2	JGHV-101-98	Air Cap	1
3	See Chart 1	Fluid Tip	1
*4	JGD-14-K10	Gasket Kit, Polyethylene (Kit of 10)	1
5	JGHV-457-98	Baffle and Gasket Kit	1
6	MSV-3-K10	Gasket, PTFE (Blue)(Kit of 10)	1
7	—	Lock Nut	1
8	—	Fluid Inlet Adapter	1
9	JGA-4044	Fluid Inlet and Nut Kit	1
*10	JGS-72-K10	Gasket Kit, PTFE (Kit of 10)	2
*11	MBD-12-K25	Spring Kit (Kit of 25)	1
*12	JGS-431-K25	Air Valve Kit (Kit of 25)	1
*13	JGS-26-K25	U-Cup Seal Kit (Kit of 25)	1
*14	JGA-15-K25	Washer Kit (Kit of 25)	1
*15	JGA-14-K25	Snap Ring Kit (Kit of 25)	1
16	JGS-449-1	Air Valve Assembly	1
*17	JGV-463-K3	Packing Kit (Kit of 3)	1
18	34411-122-K10	Packing Nut Kit (Kit of 10)	1
*19	—	Screw	1

Ref. No.	Replacement Part No.	Description	Individual Parts Required
20	JGS-478	Stud and Screw Kit (Kit includes 3 studs and 5 screws)	1
21	JGS-477-1	Trigger, Stud and Screw Kit (Kit includes 1 each)	1
22	JGA-132	Plug	1
23	P-MB-51	Nipple	1
24	JGA-497-1	Fan Adjustment Assembly	1
*25	—	Retaining Ring	1
*26	SSG-8069-K25	O-Ring, Viton (Kit of 25)	1
27	JGS-16	Adjusting Screw	1
*28	—	Spring Pad (Included with No. 29)	1
*29	MBD-19-K10	Spring Kit (Kit of 10)	1
30	—	Bushing	1
31	JGA-4041	Bushing, Spring and Knob Kit	1
32	JGA-402-FX	Fluid Needle	1
33	—	Gun Body	1

\* A quantity of necessary parts is included in **REPAIR KIT KK-4987-2** for complete gun repair and should be kept on hand for service convenience.  
 • For more limited repair, "Soft Parts Kit" **KK-5034** is also available (includes items 10, 13, 17, and 26).

## TROUBLESHOOTING

CONDITION	CAUSE	CORRECTION
Heavy top or bottom pattern 	Horn holes plugged. Obstruction on top or bottom of fluid tip. Cap and/or tip seat dirty.	Clean. Ream with non-metallic point. Clean. Clean.
Heavy right or left side pattern 	Left or right side horn holes plugged. Dirt on left or right side of fluid tip.  Remedies for the top-heavy, bottom-heavy, right-heavy, and left-heavy patterns: 1. Determine if the obstruction is on the air cap or the fluid tip. Do this by making a test spray pattern. Then, rotate the cap one-half turn and spray another pattern. If the defect is inverted, obstruction is on the air cap. Clean the air cap as previously instructed. 2. If the defect is not inverted, it is on the fluid tip. Check for a fine burr on the edge of the fluid tip. Remove with #600 wet or dry sand paper. 3. Check for dried paint just inside the opening; remove by washing with solvent.	Clean. Ream with non-metallic point. Clean.
Heavy center pattern 	Fluid flow too high for atomization air.  Material flow exceeds air cap's capacity. Spreader adjustment valve set too low. Atomizing pressure too low. Material too thick.	Balance air pressure and fluid flow. Increase spray pattern width with spreader adjustment valve. Thin or lower fluid flow. Adjust. Increase pressure. Thin to proper consistency.
Split spray pattern 	Atomization air pressure too high. Fluid flow too low.  Spreader adjusting valve set too high.	Reduce pressure at the wall or gun. Increase fluid flow (increases gun handling speed). Adjust.
Jerky or fluttering spray 	*Loose or damaged fluid tip/seat. Material level too low. Container tipped too far. Obstruction in fluid passage. Dry or loose fluid needle packing nut.	Tighten or replace. Refill. Hold more upright. Backflush with solvent. Lubricate or tighten.
Unable to get round spray	Spreader adjustment screw not seating properly. Air cap retaining ring loose.	Clean or replace. Tighten.
Will not spray	No air pressure at gun.  Fluid needle adjusting screw not open enough. Fluid too heavy for gravity feed.	Check air supply and air lines, blow out gun air passages. Open fluid needle adjusting screw. Thin material and/or change to larger tip size.
Fluid leaking or dripping from cup lid	Cup lid loose. Dirty threads on cup or lid. Cracked cup or lid.	Tight lid. Clean. Replace cup and lid.
Starved spray pattern	Inadequate material flow.	Back fluid adjusting screw out to first thread, or change to larger tip size.
Excessive overspray	Too much atomization air pressure. Gun too far from work surface. Improper stroking (arcing, gun motion too fast).	Reduce pressure. Adjust to proper distance. Move at moderate pace, parallel to work surface.
Excessive fog	Too much or too fast-drying thinner. Too much atomization air pressure.	Remix properly. Reduce pressure.
Dry spray	Air pressure too high. Gun tip too far from work surface. Gun motion too fast. Gun out of adjustment.	Reduce air pressure. Adjust to proper distance. Slow down. Adjust.
Fluid leaking from packing nut	Packing nut loose. Packing worn or dry.	Tighten, do not bind needle. Replace or lubricate.
Fluid leaking or dripping from front of gun	Packing nut too tight. Dry packing. Fluid tip or needle worn or damaged. Foreign matter in tip. Fluid needle spring broken. Wrong size needle or tip.	Adjust. Lubricate. Replace tip and needle with lapped sets. Clean. Replace. Replace.

\*Most common problem.

**ACCESSORIES**

**P-H-5516 Air Adjusting Valve**

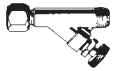

Enables user to control and reduce air usage at the gun. Ideal for low pressure spraying.

**JGA-52-K10 Leather Packings**



Used when abrasive materials are sprayed (i.e. porcelain enamel).

**42884-214-K5 (3/8") & 42884-215-K10 (5/8") Cleaning Brushes**



These brushes are helpful in cleaning threads and recesses of gun body.

**HAV-501 Adjusting Valve**



Use to control air pressure at gun.

**Spray Gun Lube SSL-10 (2 oz. bottle)**



Compatible with all paint materials: contains no silicone or petroleum distillates to contaminate paint.

**HD-503 SolventSaver™**

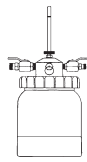

2 Quart Hose Cleaner used to clean the inside of hose and material passages of gun. 2 Gallon galvanized also available.

**WR-103 Wrench**

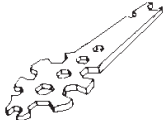

Contains all necessary tip, hose and nut sizes used on or with gun.

**JGA-4005 Air Adjusting Valve**



Allows air adjustment at the gun. Replaces JGA-132 plug.

**VS-531 Low Pressure Fluid Strainer 100 Mesh Screen**

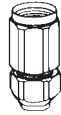

This strainer provides a final filter for trapping foreign particles in the paint supply.

**MSA-4-K10 Fluid Needle Spring (replaces MBD-19)**



Provides reduced spring force (4 lbs. versus 6 lbs.) for easier trigger pull.

**183GZ-5200 SolventSaver™ 2 Gallon Galvanized Tank Hose/Gun Cleaners**

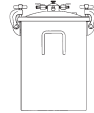

Used to clean the inside of hose and material passages of the gun.

**JGA-156-K10 Spring Clips**



Joins any single piece DeVilbiss air cap with latest version MBC-368 or MSA-1 retaining ring. Helps prevent parts loss and provides easier assembly.

**HAF-507 Whirlwind™ In-Line Air Filter**



Removes water, oil, and debris from the air line.

**KK 5033-98 Air Cap Test Kit**



The purpose of this test kit is to measure air cap atomizing air pressure at the center air port of the air cap. Used to confirm code compliance and as a daily quality control measure.

**Quick Disconnect Approved For HVLP Guns (Air)**  
High Flow Ball and Ring Type.

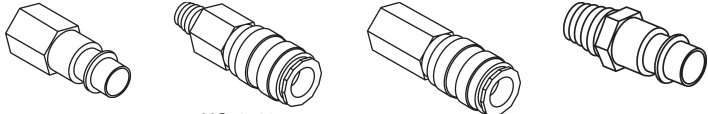

HC-4419 1/4" NPS(F)	HC-4719 1/4" NPT(M)	HC-4720 1/4" NPT(F)	HC-1166 1/4" NPT(M)
------------------------	------------------------	------------------------	------------------------

**29-3100 Scrubs® Hand Cleaner Towels**



Scrubs® are a pre-moistened hand cleaner towel for painters. No water is needed.

---

NOTES

---

## WARRANTY POLICY

DeVilbiss products are covered by Carlisle Fluid Technologies one year materials and workmanship limited warranty. The use of any parts or accessories, from a source other than Carlisle Fluid Technologies, will void all warranties. For specific warranty information please contact the closest Carlisle Fluid Technologies location listed below.

Carlisle Fluid Technologies reserves the right to modify equipment specifications without prior notice. DeVilbiss®, Ransburg®, ms®, BGK®, and Binks® are registered trademarks of Carlisle Fluid Technologies, Inc.

©2017 Carlisle Fluid Technologies, Inc.  
All rights reserved.

---

DeVilbiss is part of Carlisle Fluid Technologies, a global leader in innovative finishing technologies. For technical assistance or to locate an authorized distributor, contact one of our international sales and customer support locations.

**USA/Canada**

info@carlisleleft.com  
Tel: 1-888-992-4657  
Fax: 1-888-246-5732

**China**

mkt@carlisleleft.com.cn  
Tel: +8621-3373 0108  
Fax: +8621-3373 0308

**Germany**

info@carlisleleft.eu  
Tel: +49 (0) 6074 403 1  
Fax: +49 (0) 6074 403 281

**United Kingdom**

info@carlisleleft.eu  
Tel: +44 (0)1202 571 111  
Fax: +44 (0)1202 573 488

**Mexico**

ventas@carlisleleft.com.mx Tel: +52 55  
5321 2300 Fax: +52 55 5310 4790

**Australia**

sales@carlisleleft.com.au  
Tel: +61 (0) 2 8525 7555  
Fax: +61 (0) 2 8525 7575

**Japan**

overseas-sales@carlisleleft.co.jp Tel:  
+81 45 785 6421  
Fax: +81 45 785 6517



DISTRIBUTED BY COATING EQUIPMENT TECHNOLOGY, INC

For the latest information about our products, visit [www.carlisleleft.com](http://www.carlisleleft.com).