

**DEVILBISS**®

*Compact*  
by DEVILBISS

## HVLP GRAVITY FEED SPRAYGUN



**Product Description/Object of Declaration:** Compact

**This Product is designed for use with:** Solvent and Water based Materials

**Suitable for use in hazardous area:** Zone 1 / Zone 2

**Protection Level:** II 2 G X

**Notified body details and role:** TRAC Global Ltd (0891)

Lodging of Technical file

**This Declaration of Conformity /incorporation is issued under the sole responsibility of the manufacturer:** Finishing Brands UK Ltd,  
Ringwood Road,  
Bournemouth, BH11 9LH. UK

## EU Declaration of Conformity



**The object of the declaration described above is in conformity with the relevant Union harmonisation legislation:**

Machinery Directive 2006/42/EC

ATEX Directive 2014/34/EU

by complying with the following statutory documents and harmonized standards:

EN ISO 12100:2010 Safety of Machinery - General Principles for Design

BS EN 1953:2013 Atomising and spraying equipment for coating materials - Safety requirements

EN 1127-1:2011 Explosive atmospheres - Explosion prevention - Basic concepts

EN 13463-1:2009 Non electrical equipment for use in potentially explosive atmospheres - Basic methods and requirements

Providing all conditions of safe use / installation stated within the product manuals have been complied with and also installed in accordance with any applicable local codes of practice.

Signed for and on behalf of  
Finishing Brands UK Ltd:

Dave Smith

11-Jul-16











Director of Sales (EMEA)

Bournemouth, BH11 9LH, UK

4-3197R-2



## SAFETY WARNINGS

   	<p><b>FIRE AND EXPLOSION</b></p> <p>Solvents and coating materials can be highly flammable or combustible when sprayed. <b>ALWAYS refer to the coating material suppliers instructions and COSHH and/or SDS sheets before using this equipment.</b></p> <p>Users must comply with all local and national codes of practice and insurance company requirements governing ventilation, fire precautions, operation and house-keeping of working areas.</p> <p><b>This equipment, as supplied, is <u>NOT</u> suitable for use with <u>Halogenated Hydrocarbons</u>.</b></p> <p>Static Electricity can be generated by fluid and/or air passing through hoses, by the spraying process and by cleaning non- conductive parts with cloths. To prevent ignition sources from static discharges, earth continuity must be maintained to the spraygun and other metallic equipment used.</p>
    	<p><b>PERSONAL PROTECTIVE EQUIPMENT</b></p> <p><b>Toxic vapors</b> – When sprayed, certain materials may be poisonous, create irritation or be otherwise harmful to health. Always read all labels and safety data sheets for the material before spraying and follow any recommendations. <b>If In Doubt, Contact Your Material Supplier.</b></p> <p>The use of respiratory protective equipment is recommended at all times. The type of equipment must be compatible with the material being sprayed.</p> <p>Always wear eye protection when spraying or cleaning the spraygun</p> <p>Gloves must be worn when spraying or cleaning the equipment.</p> <p><b>Training</b> – Personnel should be given adequate training in the safe use of spraying equipment.</p>
	<p><b>MISUSE</b></p> <p>Never aim a spraygun at any part of the body.</p> <p>Never exceed the max. recommended safe working pressure for the equipment.</p> <p>The fitting of non-recommended or non-original spares may create hazards.</p> <p>Before cleaning or maintenance, all pressure must be isolated and relieved from the equipment.</p> <p>The product should be cleaned using a gun washing machine. However, this equipment should not be left inside gun washing machines for prolonged periods of time.</p>
	<p><b>NOISE LEVELS</b></p> <p>The A-weighted sound level of sprayguns may exceed 85 dB (A) depending on the set-up being used. Details of actual noise levels are available on request. It is recommended that ear protection is worn at all times when spraying.</p>
	<p><b>OPERATING</b></p> <p>Spray Equipment using high pressures may be subject to recoil forces. Under certain circumstances, such forces could result in repetitive strain injury to the operator.</p>

**PROP 65 WARNING**

WARNING: This product contains chemicals known to the State of California to cause cancer and birth defects or other reproductive harm.

Patent No. 2372465 (GB)

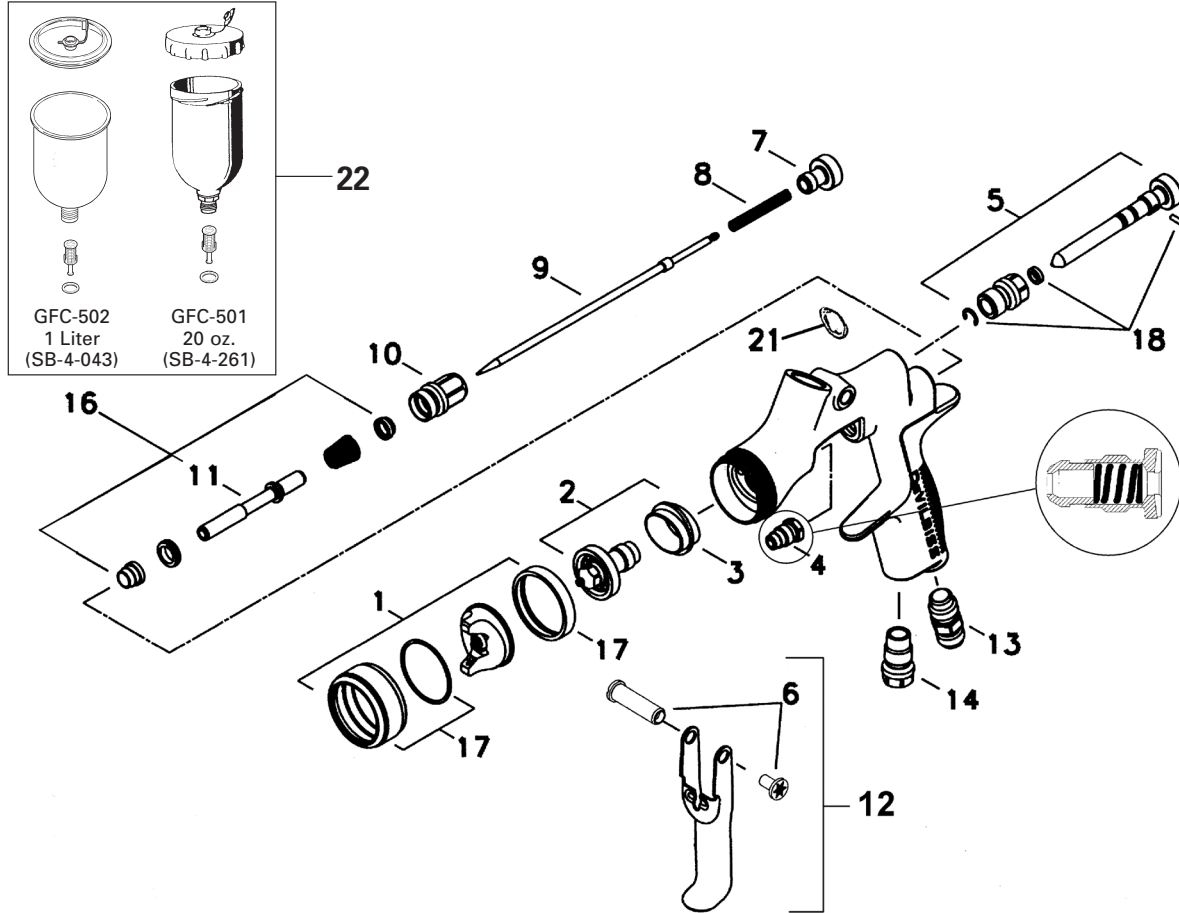

**MODEL PART NUMBER**

Example: **COM-G506B-14-02**

- Aircap \_\_\_\_\_
- Blue anodized \_\_\_\_\_
- Fluid nozzle size (14 = 1.4 mm) \_\_\_\_\_
- 00 = No cup \_\_\_\_\_
- 02 = Gravity cup, 1 liter aluminum \_\_\_\_\_
- 05 = Gravity cup, 20 oz. Acetal \_\_\_\_\_

**PARTS LIST**

Ref. No.	Description	Part Number	Qty.	Options
1	Air Cap/Retaining ring COM-506, COM-507 or COM-508	SP-100-***-K	1	506, 507, 508 e.g *** = 506
2	Nozzle	SP-200S-**-K	1	14, 18, 22 e.g ** =14 =1.4 mm
+3	Separator (Pack of 5)	SP-626-K5	1	
+4	Packing (Pack of 2)	GTI-445-K2	1	
5	Spreader Valve	SP-403-K	1	
6	Stud and Screw		1	
7	Needle Adjusting Screw	SP-614-K	1	
+8	Spring (Pack of 5)	SP-622-K5	1	
9	Needle	SP-300S-**-K	1	14, 18, 22 e.g ** =14 =1.4 mm
10	Airvalve Housing & Seal	SP-612-K	1	
•11	Spindle		1	
12	Trigger, Stud and Screw	SP-617-CR-K	1	
13	Connector	SP-611-K	1	
14	Plug	JGA-132	1	
17	Retaining Ring and Seals	SPK-102-K	1	
+18	Clip, Seal and Pin Kit (Pack of 5)	GTI-428-K5	1	
21	Cup Gasket (Pack of 5)	KGP-13-K5	1	
22	Cup Assembly		1	
•23	Air Valve Assembly Tool		1	
24	Wrench	SPN-5	1	
	Spraygun Service Kit (parts included marked + )	SPK-402-K	1	
16	Air Valve Service Kit (includes 1 each parts marked • )	SPK-101-K	1	

\*T-20 six point star wrench required.

**SPECIFICATION****Air supply connection:**

Universal 1/4" BSP and NPS

**Maximum static Air inlet pressure:**

$P_1 = 12 \text{ bar (175 psi)}$

**Nominal gun Air inlet pressure with gun triggered:**

1.5 bar (22 psi) 507 HVLP Air Cap  
1.1 bar (16 psi) 506 HVLP Air Cap  
1.0 bar (14 psi) 508 HVLP Air Cap

**Maximum Service temperature:** 40°C

**Gun Weight:** 412 g

**MATERIALS OF CONSTRUCTION**

**Gun body:** Anodized Aluminum

**Nozzle:** Stainless Steel

**Needle:** Stainless Steel

**Fluid Inlet / Fluid Passages:**

Anodized Aluminum

**Trigger:** Nickel Plated Steel

**AIR CAP SPECIFICATIONS****SP-100-506-K (Pressure Feed)**

12.2 CFM @ 16 psi inlet  
Fan Pattern Max: 11.8"

**SP-100-507-K (Pressure/Siphon)**

17.3 CFM @ 22 psi inlet  
Fan Pattern Max: 15.7"

**SP-100-508-K (Pressure Feed)**

11 CFM @ 14 psi inlet  
Fan Pattern Max: 10"

**INSTALLATION**

**Important: To ensure that this equipment reaches you in first class condition, protective coatings have been used. Flush the equipment through with a suitable solvent before use.**

1. Attach air hose to connector (13). Recommended hose size 8 mm (5/16") i.d. The hose must be conductive and electrical bond from the spraygun to earth should be checked with an ohmmeter. A resistance of less than  $10^6$  Ohms is recommended.
2. Air supply should be filtered and regulated.
3. Attach Cup assembly (22) by screwing into the Fluid Inlet of the spraygun. Tighten with a wrench.

**OPERATION**

1. Mix coating material to manufacturers instructions.
2. Fill the cup with the required amount of material. Fill to no more than 25mm (1") from the top of the cup. **DO NOT OVERFILL.**
3. Attach Cup Lid.
4. Turn needle adjusting screw (7) clockwise to prevent movement.
5. Turn spreader valve (5) counter-clockwise to fully open.
6. Adjust inlet air pressure (For recommended figures see Specifications) at the gun inlet with the gun triggered. (pressure gauge attachment shown under Accessories is recommended for this).
7. Turn needle adjusting screw counter clockwise until first thread shows.
8. Test spray. If the finish is too dry reduce airflow by reducing air inlet pressure or by the optional Airflow Valve (14). Screw the Adjusting Knob (14) in to reduce pressure.
9. If finish is too wet reduce fluid flow by turning needle screw (7) clockwise. If atomization is too coarse, increase inlet air pressure. If too fine reduce inlet pressure.
10. The pattern size can be reduced by turning adjusting valve (5) clockwise.
11. Hold gun perpendicular to surface being sprayed. Arcing or tilting may result in uneven coating.
12. The recommended spray distance is 150-200 mm (6"-8").
13. Spray edges first. Overlap each stroke a minimum of 50%. Move gun at a constant speed.
14. Always turn off air supply and relieve pressure when gun is not in use.

**PREVENTATIVE MAINTENANCE**

1. Turn off air and relieve pressure in the supply lines, or if using QD system, disconnect from airline.
2. Remove Cup Lid (20) and empty coating material into a suitable container. Clean the gun and cup, preferably in a gun wash machine. Clean the cup.
3. Check the breather hole in the Lid and the Drip Check Lid is not blocked.
4. Remove air cap (1) and clean. If any of the holes in the cap are blocked with coating material use a toothpick to clean. Never use metal wire which could damage the cap and produce distorted spray patterns
5. Ensure the tip of the nozzle (2) is clean and free from damage. Build up of dried paint can distort the spray pattern.
6. Lubrication – stud/screw (6), needle (9) and air valve (11) should be oiled each day.

**REPLACEMENT OF PARTS**

**Nozzle (2) and Needle (9)** – Remove parts in the following order: 7, 8, 9, 1 and 2. Replace any worn or damaged parts and re-assemble in reverse order. Recommended tightening torque for nozzle (2) 9.5-12 Nm (80-100 lbf in).

**Packing** – Remove parts 7, 8, 9. Unscrew cartridge (4). Fit new cartridge finger tight. Re-assemble parts 9, 8, and 7 and tighten cartridge (4) with spanner sufficient to seal but to allow free movement of needle. Lubricate with gun oil.

**Air Valve Seal Kit (16)** – (Refer to photos 1 to 28 and fig 2)

**Spreader valve (5)** – **Caution:** always ensure that the valve is in the fully open position by turning screw fully counter-clockwise before fitting to body.

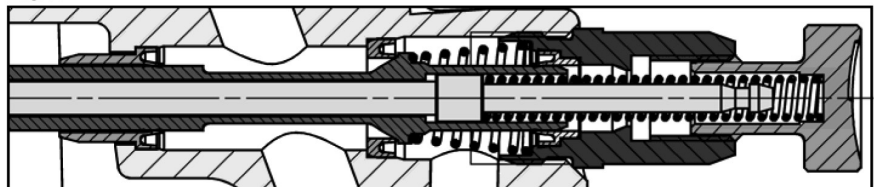
**FIG 2**



1. Remove Adjusting Knob (7), Spring (8), and Needle (9).

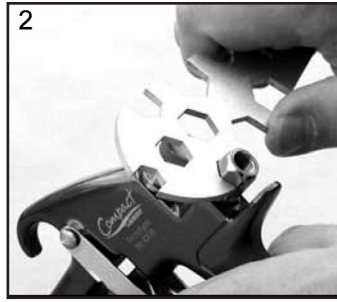

2. Loosen Housing (10).

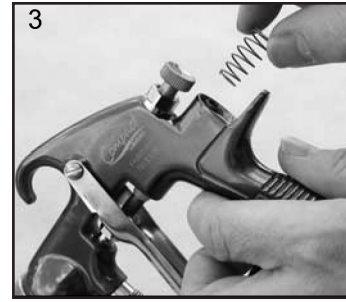

3. Remove Housing (10) and Air Valve Spring.



4. Remove Valve (11).



5. Using Service Tool SPN-7, engage groove behind the Valve Seat.



6. Remove Valve Seat.



7. Push out the Front Air Valve Seal with a finger.

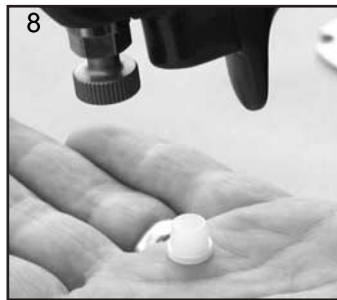

8. Turn the Gun upside down and let the Seal fall out.

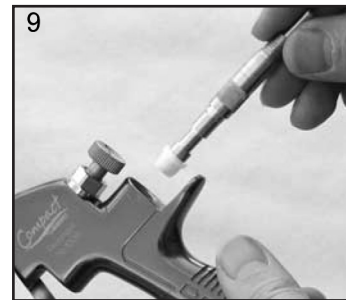

9. Fit New Front Seal to Service Tool.



10. Fit new Seal to gunbody and press firmly to ensure Seal is engaged.

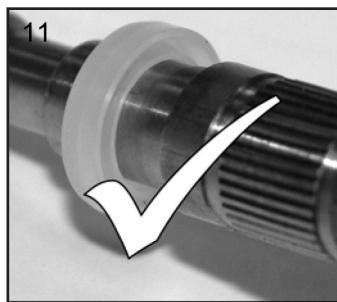

11. Fit New Valve Seat to Service Tool. Groove must face outwards.

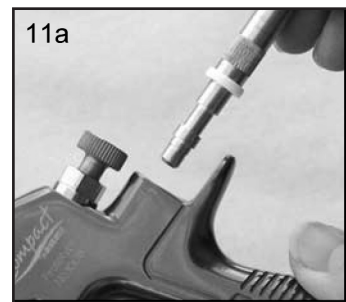

11a

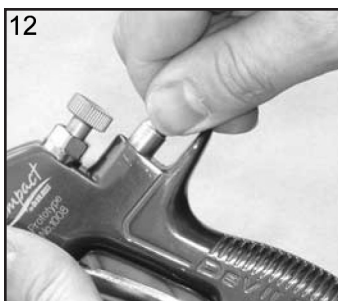

12. Fit Valve Seat to Gunbody.



13. Remove Rear Air Valve Seal from housing (10) with a hooked instrument.



14. Fit new Seal to Service Tool.



15. Fit Seal to Housing (10).



16. Replace Valve (11).



17. Replace Valve Spring and screw in Housing (10).



18. Tighten Housing.



19. Fit Needle (9).







20. Fit Spring (8) and Knob (7).



21. Adjust Needle Packing (4) with Spanner sufficient to seal but to allow free movement of needle. Lubricate with gun oil.

## TROUBLESHOOTING

CONDITION	CAUSE	CORRECTION
<b>Heavy top or bottom pattern</b> 	Horn holes plugged. Obstruction on top or bottom of fluid tip. Cap and/or tip seat dirty.	Clean. Ream with non-metallic point. Clean. Clean.
<b>Heavy right or left side pattern</b> 	Left or right side horn holes plugged. Dirt on left or right side of fluid tip.  Remedies for the top-heavy, bottom-heavy, right-heavy, and left-heavy patterns: 1. Determine if the obstruction is on the air cap or the fluid tip. Do this by making a test spray pattern. Then, rotate the cap one-half turn and spray another pattern. If the defect is inverted, obstruction is on the air cap. Clean the air cap as previously instructed. 2. If the defect is not inverted, it is on the fluid tip. Check for a fine burr on the edge of the fluid tip. Remove with #600 wet or dry sand paper. 3. Check for dried paint just inside the opening; remove by washing with solvent.	Clean. Ream with non-metallic point. Clean.
<b>Heavy center pattern</b> 	Fluid flow too high for atomization air.  Material flow exceeds air cap's capacity. Spreader adjustment valve set too low. Atomizing pressure too low. Material too thick.	Balance air pressure and fluid flow. Increase spray pattern width with spreader adjustment valve. Thin or lower fluid flow. Adjust. Increase pressure. Thin to proper consistency.
<b>Split spray pattern</b> 	Atomization air pressure too high. Fluid flow too low. Spreader adjusting valve set too high.	Reduce at transformer or gun. Increase fluid flow (increases gun handling speed). Adjust.
<b>Jerky or fluttering spray</b> 	*Loose or damaged fluid tip/seat. Baffle seal installed incorrectly. Material level too low. Container tipped too far. Obstruction in fluid passage. Dry or loose fluid needle packing nut.	Tighten or replace. Install per directions. Refill. Hold more upright. Backflush with solvent. Lubricate or tighten.
<b>Unable to get round spray</b>	Spreader adjustment screw not seating properly. Air cap retaining ring loose.	Clean or replace. Tighten.
<b>Will not spray</b>	No air pressure at gun.  Fluid needle adjusting screw not open enough. Fluid too heavy for gravity feed.	Check air supply and air lines, blow out gun air passages. Open fluid needle adjusting screw.  Thin material and/or change to larger tip size.
<b>Paint bubbles in cup</b>	Fluid tip not tight.	Tighten tip to 12-15 ft-lbs.
<b>Fluid leaking or dripping from cup lid</b>	Cup lid loose. Dirty threads on cup or lid. Cracked cup or lid.	Push in or tighten lid. Clean. Replace cup and lid.
<b>Starved spray pattern</b>	Inadequate material flow.  Low atomization air pressure.	Back fluid adjusting screw out to first thread, or change to larger tip size. Increase air pressure and rebalance gun.
<b>Excessive overspray</b>	Too much atomization air pressure. Gun too far from work surface. Improper stroking (arcing, gun motion too fast).	Reduce pressure. Adjust to proper distance. Move at moderate pace, parallel to work surface.
<b>Excessive fog</b>	Too much or too fast-drying thinner. Too much atomization air pressure.	Remix properly. Reduce pressure.
<b>Dry spray</b>	Air pressure too high. Gun tip too far from work surface. Gun motion too fast. Gun out of adjustment.	Reduce air pressure. Adjust to proper distance. Slow down. Adjust.
<b>Fluid leaking from packing nut</b>	Packing nut loose. Packing worn or dry.	Tighten, do not bind needle. Replace or lubricate.
<b>Fluid leaking or dripping from front of gun</b>	Packing nut too tight. Dry packing. Fluid tip or needle worn or damaged. Foreign matter in tip. Fluid needle spring broken. Wrong size needle or tip. Cup loose on gun.	Adjust. Lubricate. Replace tip and needle. Clean. Replace. Replace.

\*Most common problem.



## TROUBLESHOOTING (continued)

CONDITION	CAUSE	CORRECTION
<b>Fluid dripping or leaking from bottom of cup</b>	Cup gasket worn or missing below cup. Cup threads dirty.	Tighten. Replace cup gasket. Clean.
<b>Runs and sags</b>	Too much material flow. Material too thin. Gun tilted on an angle, or gun motion too slow.	Adjust gun or reduce fluid flow. Mix properly or apply light coats. Hold gun at right angle to work and adapt to proper gun technique.
<b>Thin, sandy coarse finish drying before it flows out</b>	Gun too far from surface. Too much air pressure. Improper thinner being used.	Check distance. Normally approx. 8". Reduce air pressure and check spray pattern. Follow paint manufacturer's mixing instrs.
<b>Thick, dimpled finish "orange peel"</b>	Gun too close to surface. Air pressure too low. Improper thinner being used. Material not properly mixed. Surface rough, oily, dirty.	Check distance. Normally approx. 8". Too much material coarsely atomized. Increase air pressure or reduce fluid flow. Follow paint manufacturer's mixing instrs.  Properly clean and prepare.

ACCESSORIES

**GFC-501 (Acetal) 20 Oz. Cup  
GFC-502 (Aluminum) 1-Liter Cup  
Gravity Feed Cups**

These gravity feed cups are designed to be used with EXL, FLG, GFG, GFHV, GTI or Compact gravity feed spray guns.

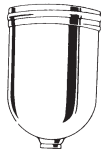

**HAV-500 OR  
HAV-501  
Adjusting Valve  
(HAV-501 SHOWN)**

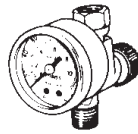

HAV-500 does not have pressure gauge. Use to control air usage at gun.

**Cleaning Brushes  
42884-214-K5 (3/8")  
42884-215-K10 (5/8")**

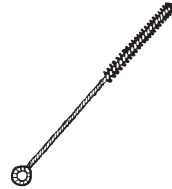

These brushes are helpful in cleaning threads and recesses of gun body.

**HAF-507-K12  
Whirlwind™  
In-Line Air Filter**

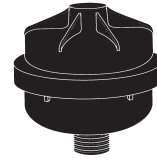

Removes water, oil, and debris from the air line.

**29-3100-K6 Scrubs®  
Hand Cleaner Towels**



Scrubs® are a pre-moistened hand cleaner towel for painters, body men and mechanics that go where you go and no water is needed.

**Spray Gun Lube  
SSL-10-K12 (2 oz. bottle)**



Compatible with all paint materials; contains no silicone or petroleum distillates to contaminate paint. SDS Sheet available upon request.

**Industrial Quick Connects  
for HVLV Guns (Air)**

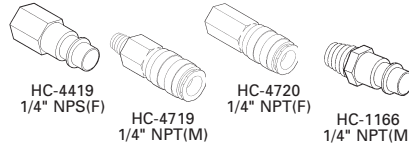

HC-4419  
1/4" NPS(F)

HC-4719  
1/4" NPT(M)

HC-4720  
1/4" NPT(F)

HC-1166  
1/4" NPT(M)

**MPV-60-K3  
Air Inlet Swivel  
(Pack of 3)**



Fits Compact gun only. Compatible with DeVilbiss high flow quick disconnects.

**SP-402-K  
Air Adjusting Valve**



Installs into gun to enable user to control and reduce air usage at the gun. Replaces SP-637 plug.

**SPN-5 Wrench**

Contains all necessary tip, hose and nut sizes used on or with gun.



**OMX-70-K48 Paint Cup Liner Kit**  
Allows quick & easy clean-up.

Consists of : 1 - Piercing Tool,  
48 - Disposable Liners, 48 - Drain Bushings

**KGP-5-K5  
Paint Filter Kit (Gravity)**

Gravity cup strainers, 50 mesh, package of 5.



**Paint Spray Respirators**

40-141 (Sm) 40-128 (Med) 40-143 (Lg)

NIOSH-Certified for respiratory protection in atmospheres not immediately dangerous to life.

**DeKups Cup System & Adapter**

- DPC-607 Reusable Cup 9 oz – Kit of 2
- DPC-606 Reusable Cup 24oz – Kit of 2
- DPC-608 Reusable Cup 34 oz – Kit of 2
- DPC-602 Disposable Cup 9 oz – Kit of 32
- DPC-601 Disposable Cup 24 oz – Kit of 32
- DPC-600 Disposable Cup 34 oz – Kit of 32
- DPC-31 Adapter

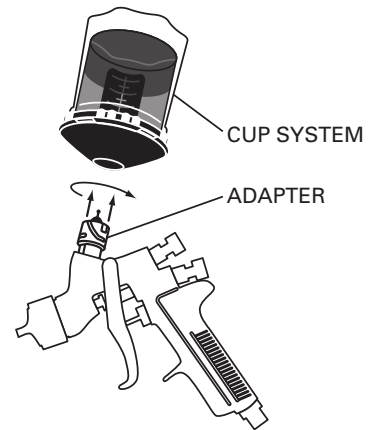

U.S. Patent numbers 6,820,824 and 7,374,111 owned by 3M Innovation Properties Co.

Additional U.S. Patents: Nos. 7,380,680; 7,354,074; 7,353,964; 7,350,418; 7,344,040; 7,263,893; 7,165,732; 7,086,549.

---

**NOTES**

---

## WARRANTY POLICY

This product is covered by Carlisle Fluid Technologies' materials and workmanship limited warranty. The use of any parts or accessories, from a source other than Carlisle Fluid Technologies, will void all warranties. Failure to reasonably follow any maintenance guidance provided may invalidate any warranty.

For specific warranty information please contact Carlisle Fluid Technologies.

Carlisle Fluid Technologies is a global leader in innovative finishing technologies. Carlisle Fluid Technologies reserves the right to modify equipment specifications without prior notice.

DeVilbiss®, Ransburg®, ms®, BGK®, and Binks®  
are registered trademarks of Carlisle Fluid Technologies, Inc.

©2018 Carlisle Fluid Technologies, Inc.  
All rights reserved.

---

For technical assistance or to locate an authorized distributor,  
contact one of our international sales and customer support locations.

<b>Region</b>	<b>Industrial / Automotive</b>	<b>Automotive Refinishing</b>
Americas	Tel: 1-800-992-4657 Fax: 1-888-246-5732	Tel: 1-800-445-3988 Fax: 1-800-445-6643
Europe, Africa, Middle East, India	Tel: +44 (0)1202 571 111 Fax: +44 (0)1202 573 488	
China	Tel: +8621-3373 0108 Fax: +8621-3373 0308	
Japan	Tel: +81 45 785 6421 Fax: +81 45 785 6517	
Australia	Tel: +61 (0) 2 8525 7555 Fax: +61 (0) 2 8525 7575	

For the latest information about our products, visit [www.carlisleleft.com](http://www.carlisleleft.com)